

1.1.2



**Terna Public Charitable Trust's
Terna Engineering College,
Nerul, Navi-Mumbai 400706**

INDEX

Criteria 1.1.2

- 1. Academic Calendar (University, Institute & Department)**
- 2. Notices of IAT/OR/PR/Submission**
- 3. Internal assessment test records.**
- 4. Expert talk Reports**

General Guidelines for conducting Academic & examination Activities

All the principals of the affiliated colleges in Engineering are hereby informed that the Detailed Schedule of the Term of Undergraduate First Year (FE), Postgraduate (M.E) in Engineering programs for Academic year 2023-24 will be as under:

Sr. No.	Particular	ODD Semester Second Half 2023 FE and ME	Particular	Even Semester First Half 2024 FE and ME
1.	Working days for all Engineering Programs	7 th August 2023 to 30 th November 2023	Working days for all Engineering Programs	8 th January 2024 to 19 th April 2024
2.	Conducting Oral Practical Examination	1 st December to 9 th December 2023	Conducting Oral Practical Examination	24 th April 2024 to 7 th May 2024
3.	Theory Examination FE, ME (SEM II)	13 th December to 22 nd December 2023	Theory Examination SE, TE, BE (SEM II)	13 th May 2024 to 24 th May 2024
4.	Commencement of New Term	1 st January 2024	Commencement of New Term	8 th July 2024

- All Faculty should be intimated for examination and examination duties as required.
- All colleges should submit Faculty assessment Form I & II on completion of approximately 70% and 70% of 1, 2, 3, 4, 5, 6, 7, 8, 9, 10, 11, 12, 13, 14, 15, 16, 17, 18, 19, 20, 21, 22, 23, 24, 25, 26, 27, 28, 29, 30, 31, 32, 33, 34, 35, 36, 37, 38, 39, 40, 41, 42, 43, 44, 45, 46, 47, 48, 49, 50, 51, 52, 53, 54, 55, 56, 57, 58, 59, 60, 61, 62, 63, 64, 65, 66, 67, 68, 69, 70, 71, 72, 73, 74, 75, 76, 77, 78, 79, 80, 81, 82, 83, 84, 85, 86, 87, 88, 89, 90, 91, 92, 93, 94, 95, 96, 97, 98, 99, 100, 101, 102, 103, 104, 105, 106, 107, 108, 109, 110, 111, 112, 113, 114, 115, 116, 117, 118, 119, 120, 121, 122, 123, 124, 125, 126, 127, 128, 129, 130, 131, 132, 133, 134, 135, 136, 137, 138, 139, 140, 141, 142, 143, 144, 145, 146, 147, 148, 149, 150, 151, 152, 153, 154, 155, 156, 157, 158, 159, 160, 161, 162, 163, 164, 165, 166, 167, 168, 169, 170, 171, 172, 173, 174, 175, 176, 177, 178, 179, 180, 181, 182, 183, 184, 185, 186, 187, 188, 189, 190, 191, 192, 193, 194, 195, 196, 197, 198, 199, 200, 201, 202, 203, 204, 205, 206, 207, 208, 209, 210, 211, 212, 213, 214, 215, 216, 217, 218, 219, 220, 221, 222, 223, 224, 225, 226, 227, 228, 229, 230, 231, 232, 233, 234, 235, 236, 237, 238, 239, 240, 241, 242, 243, 244, 245, 246, 247, 248, 249, 250, 251, 252, 253, 254, 255, 256, 257, 258, 259, 260, 261, 262, 263, 264, 265, 266, 267, 268, 269, 270, 271, 272, 273, 274, 275, 276, 277, 278, 279, 280, 281, 282, 283, 284, 285, 286, 287, 288, 289, 290, 291, 292, 293, 294, 295, 296, 297, 298, 299, 300, 301, 302, 303, 304, 305, 306, 307, 308, 309, 310, 311, 312, 313, 314, 315, 316, 317, 318, 319, 320, 321, 322, 323, 324, 325, 326, 327, 328, 329, 330, 331, 332, 333, 334, 335, 336, 337, 338, 339, 340, 341, 342, 343, 344, 345, 346, 347, 348, 349, 350, 351, 352, 353, 354, 355, 356, 357, 358, 359, 360, 361, 362, 363, 364, 365, 366, 367, 368, 369, 370, 371, 372, 373, 374, 375, 376, 377, 378, 379, 380, 381, 382, 383, 384, 385, 386, 387, 388, 389, 390, 391, 392, 393, 394, 395, 396, 397, 398, 399, 400, 401, 402, 403, 404, 405, 406, 407, 408, 409, 410, 411, 412, 413, 414, 415, 416, 417, 418, 419, 420, 421, 422, 423, 424, 425, 426, 427, 428, 429, 430, 431, 432, 433, 434, 435, 436, 437, 438, 439, 440, 441, 442, 443, 444, 445, 446, 447, 448, 449, 450, 451, 452, 453, 454, 455, 456, 457, 458, 459, 460, 461, 462, 463, 464, 465, 466, 467, 468, 469, 470, 471, 472, 473, 474, 475, 476, 477, 478, 479, 480, 481, 482, 483, 484, 485, 486, 487, 488, 489, 490, 491, 492, 493, 494, 495, 496, 497, 498, 499, 500, 501, 502, 503, 504, 505, 506, 507, 508, 509, 510, 511, 512, 513, 514, 515, 516, 517, 518, 519, 520, 521, 522, 523, 524, 525, 526, 527, 528, 529, 530, 531, 532, 533, 534, 535, 536, 537, 538, 539, 540, 541, 542, 543, 544, 545, 546, 547, 548, 549, 550, 551, 552, 553, 554, 555, 556, 557, 558, 559, 560, 561, 562, 563, 564, 565, 566, 567, 568, 569, 570, 571, 572, 573, 574, 575, 576, 577, 578, 579, 580, 581, 582, 583, 584, 585, 586, 587, 588, 589, 590, 591, 592, 593, 594, 595, 596, 597, 598, 599, 600, 601, 602, 603, 604, 605, 606, 607, 608, 609, 610, 611, 612, 613, 614, 615, 616, 617, 618, 619, 620, 621, 622, 623, 624, 625, 626, 627, 628, 629, 630, 631, 632, 633, 634, 635, 636, 637, 638, 639, 640, 641, 642, 643, 644, 645, 646, 647, 648, 649, 650, 651, 652, 653, 654, 655, 656, 657, 658, 659, 660, 661, 662, 663, 664, 665, 666, 667, 668, 669, 670, 671, 672, 673, 674, 675, 676, 677, 678, 679, 680, 681, 682, 683, 684, 685, 686, 687, 688, 689, 690, 691, 692, 693, 694, 695, 696, 697, 698, 699, 700, 701, 702, 703, 704, 705, 706, 707, 708, 709, 710, 711, 712, 713, 714, 715, 716, 717, 718, 719, 720, 721, 722, 723, 724, 725, 726, 727, 728, 729, 730, 731, 732, 733, 734, 735, 736, 737, 738, 739, 740, 741, 742, 743, 744, 745, 746, 747, 748, 749, 750, 751, 752, 753, 754, 755, 756, 757, 758, 759, 760, 761, 762, 763, 764, 765, 766, 767, 768, 769, 770, 771, 772, 773, 774, 775, 776, 777, 778, 779, 780, 781, 782, 783, 784, 785, 786, 787, 788, 789, 790, 791, 792, 793, 794, 795, 796, 797, 798, 799, 800, 801, 802, 803, 804, 805, 806, 807, 808, 809, 810, 811, 812, 813, 814, 815, 816, 817, 818, 819, 820, 821, 822, 823, 824, 825, 826, 827, 828, 829, 830, 831, 832, 833, 834, 835, 836, 837, 838, 839, 840, 841, 842, 843, 844, 845, 846, 847, 848, 849, 850, 851, 852, 853, 854, 855, 856, 857, 858, 859, 860, 861, 862, 863, 864, 865, 866, 867, 868, 869, 870, 871, 872, 873, 874, 875, 876, 877, 878, 879, 880, 881, 882, 883, 884, 885, 886, 887, 888, 889, 890, 891, 892, 893, 894, 895, 896, 897, 898, 899, 900, 901, 902, 903, 904, 905, 906, 907, 908, 909, 910, 911, 912, 913, 914, 915, 916, 917, 918, 919, 920, 921, 922, 923, 924, 925, 926, 927, 928, 929, 930, 931, 932, 933, 934, 935, 936, 937, 938, 939, 940, 941, 942, 943, 944, 945, 946, 947, 948, 949, 950, 951, 952, 953, 954, 955, 956, 957, 958, 959, 960, 961, 962, 963, 964, 965, 966, 967, 968, 969, 970, 971, 972, 973, 974, 975, 976, 977, 978, 979, 980, 981, 982, 983, 984, 985, 986, 987, 988, 989, 990, 991, 992, 993, 994, 995, 996, 997, 998, 999, 1000.

Date:

[Signature]
 Asst. Director
 Faculty of Science & Technology
 University of Mumbai

[Signature]
PRINCIPAL
FERNA ENGINEERING COLLEGE
 Nerul, Navi Mumbai - 400 706



TERNA ENGINEERING COLLEGE, NERUL, NAVI MUMBAI

DEPARTMENT OF CIVIL ENGINEERING

ACADEMIC CALENDAR FOR STAFF (2023-24) PH 2024

PRE-COMMENCEMENT ACTIVITY

Sr.No.	Date	Activity	Responsibility	Remarks
A	30-12-2023	Declaration of Institute Level Academic Calendar	Dean Academic	
B	04-12-2023 to 11-12-2023	1. Discussion and finalization on a value added course. 2. Planning of Soft skills and Technical Skill Trainings for Sem II, IV, VI and VIII Students	Principal/Dean Academics/Dean IQAC/HODs/ TPO/ Professional society chapter coordinators	
C	18-12-2023 to 30-12-2023	Placement Review, discussion and actionable	HOD, TPO, Placement coordinator	The next semester activity plans and previous semester activity reports are to be presented. Lab in charges should be in touch with system staff. HOD need to verify and
		Review and Planning of activities of all professional bodies	HODs/ Professional society coordinator	
		Preventive/Breakdown Maintenance, Calibration, Installation of Software etc.	Lab incharges	
D	01-01-2024	New faculty joining	HOD	
E	01-01-2024	Departmental meeting (Pre-semester)	HOD, All Staff	
		Display of Divisions/Roll No/ Batches	Time table I/C, APC, HOD	
		Display of Time table	Time table I/C, APC, HOD	
F	03-01-2024	Display of teaching plan in ERP	All Staff	
	08-01-2024	COMMENCEMENT OF TERM		
	08-01-2024	1. HOD's Address to students 2. Undertaking from Students to be taken 3. Orientation of students 4. Instructional day	CA/APC/HOD	Undertaking for Attendance from students has to be collected



PRINCIPAL
TERNA ENGINEERING COLLEGE
Nerul, Navi Mumbai - 400 704

Week	Date	Activity	Staff	Remarks
Week 2	08-01-2024 to 12-01-2024	INSTRUCTIONAL DAYS	All Staff, APC, HOD	
	12-01-2024	National Youth Day	All Staff, APC, HOD	
	15-01-2024 to 19-01-2024	INSTRUCTIONAL DAYS	All Staff, APC, HOD	
		Seminar/workshop on Report writing and presentation preparation of Project	Project coordinator, All Staff, HOD	MOM to be prepared
		BE PROJECT & SE, TE MINI PROJECT REVIEW I	All Project Coordinators / Guides/ APC, HOD	
		Mentor Meeting-1	Mentors, Mentor coordinator	Report to be prepared
	16-01-2024	National Startup Day	All Staff, APC, HOD	
	19-01-2024	Workshop on "Entrepreneurship and Innovation" as Career Opportunity	IIC/E Cell	
		Women's Self-Defense and Fitness workshop	ICC/WDC	
	Week 3	22-01-2024 to 25-01-2023	INSTRUCTIONAL DAYS	All Staff, APC, HOD
Audit by Internal Quality Assurance Cell (IQAC)			IQAC Dean, IQAC coordinators, HOD, APC, ALL STAFF	
25-01-2024		My Story - Motivational Session by Successful Entrepreneur/Start-up founder	IIC/E Cell	
		Awareness session on personal hygiene	ICC/WDC	
26-1-2023		REPUBLIC DAY		
29-01-2024 to 02-02-2024	INSTRUCTIONAL DAYS	All Staff, APC, HOD		
	Defaulter's List-1(Period 08/01/2024 to 31/01/2024)	HOD,APC,CAs		



PRINCIPAL
TERNA ENGINEERING COLLEGE
Nerul, Navi Mumbai - 400 706

Week 4	02-02-2024	Session on Problem Solving and Ideation Workshop	IIC/E Cell	
		Seminar on healthcare	ICC/WDC	
	02-02-2024	Monthly review meeting of academic activities	All Staff, HOD	
Week 5	05-02-2024 to 09-02-2024	INSTRUCTIONAL DAYS	All Staff, APC, HOD	
		Stakeholders' Feedback - I	IQAC Dean, IQAC coordinators, HOD, APC, ALL STAFF	
	09-02-2024	Health Check-up camp for All	ICC/WDC	
Week 6	12-02-2024 to 16-02-2024	INSTRUCTIONAL DAYS	All Staff, PAC, HOD	
		Mentor Meeting- 2	Mentors, Mentor coordinator	Report to be prepared
	14-02-2024	Submission of IAT- I Paper	All Staff/APC/HOD	
	16-02-2024	Departmental meeting	All Staff, HOD	
	16-02-2024	Health Check-up camp for All	ICC/WDC	
		Workshop on Design Thinking, Critical thinking and Innovation Design	IIC/E Cell	
	19-2-2024	CHHATRAPATI SHIVAJI MAHARAJ JAYANTI		
Week 7	20-02-2024 to 22-02-2024	Internal Assessment Test I (IAT I)	All staff, Exam I/C, IQAC coordinator	
	20-02-2024	EM-IV, SA (SE)	DDSS, WRE (TE)	CM. IWT (BE)
	21-02-2024	SUR, BMCT (SE)	GE-II, EE (TE)	RRRs, PM (BE)
	22-02-2024	FM- II (SE)	CET (TE)	



PRINCIPAL
TERNA ENGINEERING COLLEGE
 Nerul, Navi Mumbai - 400 706

Week 8	23-02-2024	INSTRUCTIONAL DAYS	All Staff, APC, HOD		
	23-02-2024	Expert talk on Process of Innovation Development, Technology Readiness Level (TRL); Commercialization of Lab Technologies & Tech-Transfer	IIC/E Cell		
	26-02-2024 to 01-03-2024	INSTRUCTIONAL DAYS	All Staff, APC, HOD		
		Industrial Visits	IV coordinator	Reports to be prepared	
	27-02-2024 to 01-03-2024	Remedial Classes	All Staff		
	01-03-2024	Defaulter's List-2(Period 01/02/2024 to 30/02/2024)	HOD/APC/CAs		
		Monthly review meeting of academic activities	All Staff, HOD		
		PARENT TEACHER INTERACTION MEETING	All Staff, APC, HOD		
	Week 9	01-03-2024 to 04-03-2024	SPORTEC	Sports Incharge	
		05-03-2024 to 06-03-2024	AVALON- Technical Festival	Technical Program Incharge & Students' council	
Session on Achieving Problem-Solution Fit and Product-Market Fit			IIC/E Cell		



	05-03-2024 to 06-03-2024	RESONANCE - Cultural Festival	Cultural Festival Incharge & Student/ council	
		Poster making, Drawing Competition	ICC/WDC	
Week 10	11-03-2024 to 15-03-2024	INSTRUCTIONAL DAYS	All Staff, APC, HOD	
		Expert Lecture series	All Staff, APC, HOD	Reports to be prepared
	11-03-2024	International Women's Day	ICC/WDC	
Week 11	18-03-2024 to 22-03-2024	INSTRUCTIONAL DAYS	All Staff, APC, HOD	
		BE PROJECT & SITE MINI PROJECT REVIEW 2	All Project Coordinators / Guides/ APC, HOD	
	22-03-2024	Session/ Workshop on Business Model Canvas (BMC)	ICC Cell	
Week 12	25-03-2024	HOLIDAY		
	26-03-2024 to 28-03-2024	INSTRUCTIONAL DAYS	All Staff, APC, HOD	
		Mentor Meeting- 3	Mentors, Mentor coordinator	Report to be prepared
	29-03-2024	GOOD FRIDAY		
		INSTRUCTIONAL DAYS	All Staff, APC, HOD	

PRINCIPAL
TERNA ENGINEERING COLLEGE
 Nerul, Navi Mumbai - 400 706



Week 13	01-04-2024 to 05-04-2024	Poster Competition for Civil Engg. Students	All Project Coordinators / Guides/ APC, HOD	
		Stakeholders' Feedback - 2	IQAC Dean, IQAC coordinators, HOD, APC, ALL STAFF	3
	01-04-2024	Defaulter's List-2(Period 01/03/2024 to 30/03/2024)	HOD/APC/CAs	
		Monthly review meeting of academic activities	All Staff, HOD	
		Choice of Institute level and program specific Elective subjects TE and BE for sem V and VII	Class advisors, HODs, Dean Academics	
05-04-2024	Workshop on Intellectual Property Rights (IPRs) and IP management for start up	HC/E Cell		
Week 14	08-04-2024 & 10-04-2024	INSTRUCTIONAL DAYS	All Staff, APC, HOD	
		Submission of IAT- II Paper	All Staff/APCs/HODs	
	09-04-2024	GUDI PADAWA		
	11-04-2024	RAMAZAN EID		
	12-04-2024	Submission of load distribution of SH2024	HOD	
	12-04-2024, 15-04-2024 to 16-04-2024	Internal Assessment Test II (IAT I+C761)	All staff, Exam I/C, IQAC coordinator	
	12-04-2024	EM-IV, SA (SE)	ODS, WRE (TE)	CM. IWT (DE)

PRINCIPAL
TERNA ENGINEERING COLLEGE
 Nerul, Navi Mumbai - 400 706

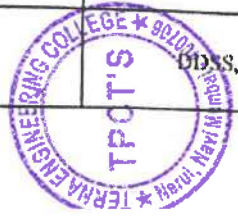

	14-04-2024	DR. BABASAHEB AMBEDKAR JAYANTI		
Week 15	15-04-2024	SUR, BMCT (SE)	GE-II, EE (TE)	RRRs, PM (BE)
	16-04-2024	FM- II (SE)	CET (TE)	
	17-04-2024	RAMNAVAMI		
	18-04-2024	Final Defaulter's List (Period 08/01/2024 to 18/04/2024)	HOD/APC/CAs	
	18-04-2024 & 19-04-2024	Final Certification and Submission of Term Work Display of viva schedule	All Staff, APC, HOD	
		Submission of Project Reports and certification	All HOD's, APCs, Class Advisors	
		Course End Survey, Graduate Exit Survey	HOD/APC/CAs	Reports to be prepared
		Finalization of Institute level and program specific Elective subjects TE and BE for sem V and VII	HOD/APC/CAs	Reports to be prepared
		Manpower requirement for next semester	HOD, HR	
	19-04-2024	END OF TERM		
19-04-2024	End sem review meeting of academic activities	All Staff, HOD		
21-04-2024	WORLD CREATIVITY & INNOVATION C75DAY	IIC/E Cell		
26-04-2024	WORLD INTELLECTUAL PROPERTY DAY	IIC/E Cell		

PRINCIPAL
TERNA ENGINEERING COLLEGE
 Nerul, Navi Mumbai - 400 706

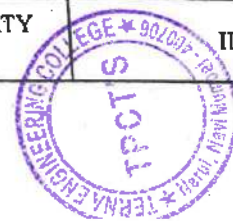

Week 14

11-04-2024	RAMAZAN EID		
12-04-2024	Submission of load distribution of SH2024	HOD	
12-04-2024, 15-04-2024 to 16-04-2024	Internal Assessment Test II (IAT II)	All staff, Exam I/C, IQAC coordinator	
12-04-2024	EM-IV, SA (SE)	DDSS, WRE (TE)	CM. IWT (BE)
14-04-2024	DR. BABASAHEB AMBEDKAR JAYANTI		

Week 15

15-04-2024	SUR, BMCT (SE)	GE-II, EE (TE)	RRRs, PM (BE)
16-04-2024	FM- II (SE)	CET (TE)	
17-04-2024	RAMNAVAMI		
18-04-2024	Final Defaulter's List (Period 08/01/2024 to 18/04/2024)	HOD/APC/CAs	
18-04-2024 & 19-04-2024	Final Certification and Submission of Term Work Display of viva schedule	All Staff, APC, HOD	
	Submission of Project Reports and certification	All HOD's, APCs, Class Advisors	
	Course End Survey, Graduate Exit Survey	HOD/APC/CAs.	Reports to be prepared
	Finalization of Institute level and program specific Elective subjects TE and BE for sem V and VI	HOD/APC/CAs	Reports to be prepared



19-04-2024	Manpower requirement for next semester	HOD, HR	
END OF TERM			
19-04-2024	End sem review meeting of academic activities	All Staff, HOD	
21-04-2024	WORLD CREATIVITY & INNOVATION C75DAY	IIC/E Cell	
26-04-2024	WORLD INTELLECTUAL PROPERTY DAY	IIC/E Cell	
24-04-2024 to 07-05-2024	Conduction of Oral/Practical exam (SE, TE & BE)	All staff, Exam I/C, IQAC coordinator	
01-05-2024	MAHARASHTRA DAY		
01-05-2024 to 31-05-2024	Academic Advisory committee Meeting	HOD, HR	
13-05-2024 to 24-05-2024	Audit by Internal Quality Assurance Cell (IQAC)	IQAC Dean, IQAC coordinators, HOD, APC, ALL STAFF	Reports to be prepared
13-05-2024 to 24-04-2024	Theory Examination (SE/ TE/ BE -sem IV/ V/ VIII)	All staff, Exam I/C	
27-05-2024 to 07-06-2024	Theory Examination (SE/ TE/ BE -sem III/ V/ VII)	All staff, Exam I/C	
10-06-2024 to 10-07-2024	Summer Training Program - All students	Training Coordinator, TPO Coordinator, HOD	

[Signature]
APC

[Signature]
PRINCIPAL
PERNA ENGINEERING COLLEGE
Nerul, Navi Mumbai - 400 706



ACADEMIC CALENDAR - Second Half of 2023

Date: 01/07/2022

Activity Plan (UG III/V/VII)

R1

DEPARTMENT OF CIVIL ENGINEERING				
PRE-COMMENCEMENT ACTIVITY				
Sr.No.	Date	Activity	Responsibility	Remarks
A	03-07-2023	Declaration of Institute Level Academic Calendar	Dean Academic	
B	04-07-2023	Department wise requirement (Equipment, Consumables if any)	HOD/Store in charge	
		Department-wise Academic Calendar	Time table I/C, PAC, HOD	The next semester activity plans to be planned
C	01-07-2023 to 07-07-2023	Preventive/Breakdown Maintenance, Calibration, Installation of Software etc.	Lab incharges	Lab in charges should be in touch with system staff. HOD need to verify and submit completion report to principal
D	03-07-2023	New faculty joining	HOD	
E	05-07-2023	Departmental meeting (Pre-semester)	All Staff, HOD	
F		Display of Time table	Time table I/C, PAC, HOD	

PRINCIPAL
TERNA ENGINEERING COLLEGE
Nerul, Navi Mumbai - 400 706



	10-07-2023	COMMENCEMENT OF TERM (SEM V & VII)		
Week 1	10-07-2023	1. HOD's Address to students 2. Undertaking from Students to be taken 3. Orientation of students 4. Instructional day	CAs/PAC/HOD	Undertaking for Attendance from students has to be collected. HOD address subject to change based on students attd
	11-07-2023 to 14 -07-2023	INSTRUCTIONAL DAYS	All Staff, PAC, HOD	
	17-07-2023	COMMENCEMENT OF TERM (SEM III)		
Week 2	17-07-2023 to 21 -07-2023	INSTRUCTIONAL DAYS	All Staff, PAC, HOD	
		Seminar/workshop on Report writing and presentation preparation of Project	Project coordinator, All Staff, HOD	MOM to be prepared
		Mentor Meeting-1	Mentors, Mentor coordinator	Mentor list is to be prepared and circulated. The report of Mentor meetings needs to be kept ready.
	22-07-2023 to 28-07-2023	Short Term Training Programme	All Staff, HOD	
Week 3	24-07-2023 to 28-07-2023	INSTRUCTIONAL DAYS	All Staff, PAC, HOD	
		BE PROJECT & MINI PROJECT REVIEW 1	All Project Coordinators / Guides/ PAC, HOD	
	29 - 07-2023	MUHARRAM		
Week 4	31-07-2023 to 04 -08-2023	INSTRUCTIONAL DAYS	All Staff, PAC, HOD	
	01-08-2023	Defaulter's List-1(Period 10-07-23 to 31-07-2023)	HOD/PAC/CAs	
	04-08-2023	Monthly review meeting of academic activities	All Staff, HOD	

PRINCIPAL
TERNA ENGINEERING COLLEGE
Nerul, Navi Mumbai - 400 706



Week 6	07-08-2023 to 11-08-2023	INSTRUCTIONAL DAYS	- All Staff, PAC, HOD		
Week 6	14-08-2023	INSTRUCTIONAL DAY	All Staff, PAC, HOD		
	15-08-2023	INDEPENDENCE DAY			
	16-08-2023	PARSI NEW YEAR			
	17-08-2023 to 18-08-2023	INSTRUCTIONAL DAYS	All Staff, PAC, HOD		
		Mentor Meeting- 2	Mentors, Mentor coordinator	Report to be prepared	
Week 7	21-08-2023 to 25-08-2023	INSTRUCTIONAL DAYS	All Staff, PAC, HOD		
		Submission of IAT -1 Paper	All Staff/IQAC coordinator/HODs		
		BE PROJECT & MINI PROJECT REVIEW 2	All Project Coordinators / Guides/ PAC, HOD		
	25-08-2023	Expert Lecture	All Staff, HOD		
Week 8	28-08-2023 to 29-08-2023	INSTRUCTIONAL DAYS	All Staff, PAC, HOD		
	30-08-2023 to 01-09-2023	Internal Assessment Test I (SE, TE and BE) (IAT I)	All staff, Exam I.C, IQAC coordinator		
	30-08-2023	EM-III, MOS (SE)	TRCS, AH (TE)	DDRCS, QSEV (BE)	
	31-08-2023	EG, APDB (SE)	GE-I, TRE, (TE)	DLOC-III, DLOC-IV (BE)	
	01-09-2023	FM-1 (SE)	DLOC-I (TE)	DLOC-I (BE)	
	01-09-2023	Defaulter's List-2 (Period 01-08-23 to 30-8-2023)	HOD/PAC/CA		
	Week 9	04-09-2023 to 06-09-2023	INSTRUCTIONAL DAYS	All Staff, PAC, HOD	
		08-09-2023	Result declaration of IA-I (SE, TE and BE)	All staff, Exam I.C, IQAC	

PRINCIPAL
 PFERNA ENGINEERING COLLEGE
 Nerul, Navi Mumbai - 400 706



	05-09-2023	TEACHERS' DAY	All staff	
	06-09-2023	Departmental meeting	All Staff, HOD	
	07-09-2023	GOPALKALA - DAHI-HANDI		
	05-09-2023, 08-09-2023 & 11-09-2023	Infrastructure Feedback	HOD's/Class Advisors	
Week 10	11-09-2023 to 15-09-2023	Remedial Classes	All staff, Exam I/C, IQAC coordinator	
		INSTRUCTIONAL DAYS	All Staff, PAC, HOD	
	15-09-2023	ENGINEERS' DAY	All staff	
Week 11	18-09-2023	INSTRUCTIONAL DAYS	All Staff, PAC, HOD	
	19-09-2023 to 23-09-2023	GANESH CHATURTHI - MID SEM BREAK		
Week 12	25-09-2023 to 27-09-2023, 29-09-2023	INSTRUCTIONAL DAYS	All Staff, PAC, HOD	
		Industrial Visits	All staff, HOD, PAC	
		Orientation on Institute level and program specific Elective subjects TE and BE for sem VI and VMI	All Staff	

PRINCIPAL
PERNA ENGINEERING COLLEGE
 Nerul, Navi Mumbai - 400 706



	29-09-2023	Expert Lecture	All Staff, HOD	
	28-09-2023	ANANT CHATURDASHI & ID-E-MILAD		
Week 13	02-10-2023	MAHATMA GANDHI JAYANTI		
	03-10-2023 to 06-10-2023	INSTRUCTIONAL DAYS	All Staff, PAC, HOD	
		Mentor Meeting- 3	Mentors, Mentor coordinator	Report to be prepared
	03-10-2023	Defaulter's List-3(Period 01-09-2023 to 31-09-2023)	HOD/PAC/CAs	
	06-10-2023	Departmental meeting	All Staff, HOD	
	03-10-2023 to 07-10-2023	FEEDBACK ON ACADEMIC PERFORMANCE	HOD's/Class Advisors	Online Feedback
	Week 14	09-10-2023 to 13-10-2023	INSTRUCTIONAL DAYS	All Staff, PAC, HOD
Finalisation of Institute level and program specific Elective subjects TE and BE for sem VI and VIII			All Staff, PAC, HOD	
BE PROJECT & MINI PROJECT REVIEW 3			All Project Coordinators / Guides/ PAC, HOD	
Submission of IAT -1 Paper			All Staff/IQAC coordinator/HODs	
Week 15	16-10-2023 to 19-10-2023	INSTRUCTIONAL DAYS	All Staff, PAC, HOD	
		Course End Survey	HOD's/Class Advisors	Online Feedback

PRINCIPAL
TERNA ENGINEERING COLLEGE
 Nerul, Navi Mumbai - 400 705



Week 16	20-10-2023 to 25-10-2023	Internal Assessment Test II (SE, TE and BE) (IAT I)	All staff, Exam I/C, IQAC coordinator	
	20-10-2023	EM-III, MOS (SE)	TRCS, AH (TE)	DDRCS, QSEV (BE)
	23-10-2023	EG, APDB (SE)	GE-I, TRE, (TE)	DLOC-III, DLOC-IV (BE)
	25-10-2023	FM- I (SE)	DLOC-I (TE)	ILOC-I (BE)
	24-10-2023	DASARA		
	26-10-2023 & 27-10-2023	INSTRUCTIONAL DAYS	All Staff, PAC, HOD	
		Expert Lecture	All Staff, HOD	
		Term work Submission (TE, BE)	All staff, Exam I/C, IQAC coordinator	
	27-10-2023	END OF TERM (TE & BE)		
	28-10-2023 & 09-11-2023	Conducting oral and Practical examination TE, BE	All staff, Exam I/C, IQAC coordinator	
30-10-2023 & 03-11-2023	INSTRUCTIONAL DAYS (SE)	All Staff, PAC, HOD		
02-11-2023 & 03-11-2023	Term work Submission (SE)	All staff, Exam I/C, IQAC coordinator		
03-11-2023	END OF TERM (SE)			
04-11-2023 to 11-11-2023	Conducting oral and Practical examination SE	All staff, Exam I/C, IQAC coordinator		
12-11-2023				

PRINCIPAL
DIPAWALI - LAXMI POOJAN
TERNA ENGINEERING COLLEGE
 Nerul, Navi Mumbai - 400 706



	12-11-2023	DIPAWALI - BALIPRATIPADA		
	12-11-2023	DIPAWALI - BHAUBEEJ		
		Audit by Internal Quality Assurance Cell (IQAC)	All depts.	
	22-11-2023 & 06-12-2023	Commencement of Theory Exam SE, TE and BE Sem III, Sem V and Sem VII	All staff, Exam I/C, IQAC coordinator	
	27-11-2023	GURU NANAK JAYANTI		
	08-12-2023 & 20-12-2023	Commencement of Theory Exam SE, TE and BE Sem IV, Sem VI and Sem VIII	All staff, Exam I/C, IQAC coordinator	
	08-01-2024	Commencement of NEW TERM	All depts.	

APC

APC

Principal

PRINCIPAL

Principal

TERNA ENGINEERING COLLEGE

Nerul, Navi Mumbai - 400 706

HoD

HoD



TERNA ENGINEERING COLLEGE, NERUL

Department of Civil Engineering

Academic Year 2023-24 (FH24)

Date: 16th February, 2024

NOTICE

All the students of SE, TE, & BE are informed that their IAT-I will be conducted from 20 Feb to 22 Feb. Detailed table will be displayed on the notice board soon.

Exam Coordinator

HoD

PRINCIPAL
TERNA ENGINEERING COLLEGE
Nerul, Navi Mumbai - 400 706

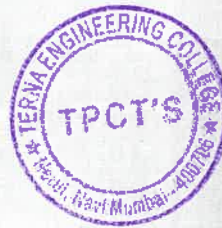

TERNA ENGINEERING COLLEGE, NERUL

Department of Civil Engineering

Academic Year 2023-24 (SH23)

Date: 6th September, 2023

NOTICE

All the students of SE, TE & BE are informed that their IAT-I will be conducted from 11th Sept 2023 to 13th Sept 2023. Detailed time table will be displayed on notice board soon.

Exam Co-ordinator

HOD

PRINCIPAL
TERNA ENGINEERING COLLEGE
Nerul, Navi Mumbai - 400 706





TPCT's TERNA ENGINEERING COLLEGE
DEPARTMENT OF CIVIL ENGINEERING
Academic Time Table 2023-2024

IAT-I TIMETABLE FH24
SE (SEM IV)

S. No.	DATE	TIME	SUBJECT
1	20-02-2024 TUESDAY	10:00-11:00	Engineering Mathematics-IV
2		2:00-3:00	Structural Analysis
3	21-02-2024 WEDNESDAY	10:00-11:00	Surveying
4		2:00-3:00	Building Materials & Concrete Technology
5	22-02-2024 THURSDAY	10:00-11:00	Fluid Mechanics- II

Exam Co ordinator

HoD

PRINCIPAL
TERNA ENGINEERING COLLEGE
Nerul, Navi Mumbai - 400 706



TPCT's TERNA ENGINEERING COLLEGE
DEPARTMENT OF CIVIL ENGINEERING
Academic Time Table 2023-2024

IAT-I TIMETABLE FH24
TE (SEM VI)

SLNO	DATE	TIME	SUBJECT
1	20-02-2024 TUESDAY	10:00-11:00	Design & Drawing of Steel Structures
2		2:00-3:00	Water Resources Engineering
3	21-02-2024 WEDNESDAY	10:00-11:00	Geotechnical Engineering-II
4		2:00-3:00	Environmental Engineering
5	22-02-2024 THURSDAY	10:00-11:00	Construction Equipment & Techniques

Valas
Exam Co ordinator

[Signature]
HoD

PRINCIPAL
 TERNA ENGINEERING COLLEGE
 Nerul, Navi Mumbai - 400 706



TPCT's TERNA ENGINEERING COLLEGE
DEPARTMENT OF CIVIL ENGINEERING
Academic Time Table 2023-2024

IAT-I TIMETABLE FH24
BE (SEM VIII)

S. No.	DATE	TIME	SUBJECT
1	20-02-2024 TUESDAY	11:30-12:30	Construction Management
2		3:30-4:30	Industrial Waste Treatment
3	21-02-2024 WEDNESDAY	11:30-12:30	Repairs, Rehabilitation and Retrofitting of structures
4		3:30-4:30	Project Management

Wadhwa
Exam Co ordinator

[Signature]
PRINCIPAL
TERNA ENGINEERING COLLEGE
Nerul, Navi Mumbai - 400 706



[Signature]
HoD

TPCT's TERNA ENGINEERING COLLEGE
DEPARTMENT OF CIVIL ENGINEERING
Academic Time Table 2023-2024

SE (SEM III)
IAT-I TIMETABLE SH23

S. No.	DATE	TIME	SUBJECT
1	11-09-2023	10:00-11:00	Engineering Mathematics-III
2	Monday	2:00-3:00	Mechanics of Solids
3	12-09-2023	10:00-11:00	Engineering Geology
4	Tuesday	2:00-3:00	Architectural Planning & Design of Buildings
5	13-09-2023	10:00-11:00	Fluid Mechanics-I
	Wednesday		

DEPT. EXCELLENCE

HOD

 **PRINCIPAL**
TERNA ENGINEERING COLLEGE
Nerul, Navi Mumbai - 400 706



TPCT's TERNA ENGINEERING COLLEGE

DEPARTMENT OF CIVIL ENGINEERING

Academic Time Table 2023-2024

TE (SEM V)

IAT-I TIMETABLE SH23

S. No.	DATE	TIME	SUBJECT
1	11-09-2023 Monday	10:00-11:00	Theory of Reinforced Concrete Structures
2		2:00-3:00	Applied Hydraulics
3	12-09-2023 Tuesday	10:00-11:00	Geotechnical Engineering-I
4		2:00-3:00	Transportation Engineering
5	13-09-2023 Wednesday	10:00-11:00	Building Services & Repairs

DEPT. EXAM I/C

PRINCIPAL
TERNA ENGINEERING COLLEGE
400 706

HOD



TPCT's TERNA ENGINEERING COLLEGE
DEPARTMENT OF CIVIL ENGINEERING
Academic Time Table 2023-2024

BE (SEM VII)
IAT-I TIMETABLE SH23

S. No.	DATE	TIME	SUBJECT
1	11-09-2023 Monday	10:00-11:00	Design & Drawing of Reinforced Concrete Structures
2		2:00-3:00	Advanced Construction Technology
3	12-09-2023 Tuesday	10:00-11:00	Quantity Survey, Estimation and Valuation
4		2:00-3:00	Solid hazardous waste management
5	13-09-2023 Wednesday	10:00-11:00	Disaster Management and Mitigation Measures



PRINCIPAL

TERNA ENGINEERING COLLEGE

Phone: 400 706



DEPT. EXAMS I/C





HOD

TPCT's TERNA ENGINEERING COLLEGE
DEPARTMENT OF CIVIL ENGINEERING
SE (SEM IV)
IAT-II TIMETABLE FH24

S. No.	DATE	TIME	SUBJECT
1	12-04-2024 FRIDAY	10:00-11:00	Engineering Mathematics-IV
2		2:00-3:00	Structural Analysis
3	15-04-2024 MONDAY	10:00-11:00	Surveying
4		2:00-3:00	Building Materials & Concrete Technology
5	16-04-2024 TUESDAY	10:00-11:00	Fluid Mechanics- II

Exam Co ordinator

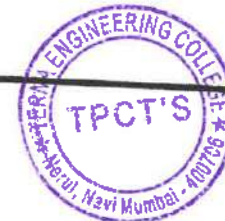

PRINCIPAL
TERNA ENGINEERING COLLEGE
Nerul, Navi Mumbai - 400 706



HoD

TPCT's TERNA ENGINEERING COLLEGE
DEPARTMENT OF CIVIL ENGINEERING
TE (SEM VI)
IAT-II TIMETABLE FH24

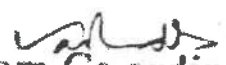
S. No.	DATE	TIME	SUBJECT
1	12-04-2024 FRIDAY	10:00-11:00	Design & Drawing of Steel Structures
2		2:00-3:00	Water Resources Engineering
3	15-04-2024 MONDAY	10:00-11:00	Geotechnical Engineering-II
4		2:00-3:00	Environmental Engineering
5	16-04-2024 TUESDAY	10:00-11:00	Construction Equipment & Techniques

Exam Co ordinator

PRINCIPAL
TERNA ENGINEERING COLLEGE
Nerul, Navi Mumbai - 400 706



HoD

TPCT's TERNA ENGINEERING COLLEGE
DEPARTMENT OF CIVIL ENGINEERING
BE (SEM VIII)
IAT-II TIMETABLE FH24

S. No.	DATE	TIME	SUBJECT
1	12-04-2024 FRIDAY	11:30-12:30	Construction Management
2		3:30-4:30	Industrial Waste Treatment
3	15-04-2024 MONDAY	11:30-12:30	Repairs, Rehabilitation and Retrofitting of structures
4		3:30-4:30	Project Management

Exam Co ordinator

PRINCIPAL
TERNA ENGINEERING COLLEGE
Nerul, Navi Mumbai - 400 706



HoD

TPCT's TERNA ENGINEERING COLLEGE
DEPARTMENT OF CIVIL ENGINEERING
Academic Time Table 2023-2024

SE (SEM III)
IAT-II TIMETABLE SH23

S. No.	DATE	TIME	SUBJECT
1	20-10-2023 Friday	10:00-11:00	Engineering Mathematics-III
2		2:00-3:00	Mechanics of Solids
3	23-10-2023 Monday	10:00-11:00	Engineering Geology
4		2:00-3:00	Architectural Planning & Design of Buildings
5	25-10-2023 Wednesday	10:00-11:00	Fluid Mechanics- I

DEPT. EXAM I/C

HOD

PRINCIPAL
TERNA ENGINEERING COLLEGE
Nerul, Navi Mumbai - 400 706



TPCT's TERNA ENGINEERING COLLEGE

DEPARTMENT OF CIVIL ENGINEERING

Academic Time Table 2023-2024

TE (SEM V)

IAT-II TIMETABLE SH23

S. No.	DATE	TIME	SUBJECT
1	20-10-2023 Friday	10:00-11:00	Theory of Reinforced Concrete Structures
2		2:00-3:00	Applied Hydraulics
3	23-10-2023 Monday	10:00-11:00	Geotechnical Engineering-I
4		2:00-3:00	Transportation Engineering
5	25-10-2023 Wednesday	10:00-11:00	Building Services & Repairs

DEPT. EXAM I/C

HOD

PRINCIPAL
TERNA ENGINEERING COLLEGE
Nerul, Navi Mumbai - 400 706



TPCT's TERNA ENGINEERING COLLEGE

DEPARTMENT OF CIVIL ENGINEERING

Academic Time Table 2023-2024

BE (SEM VII)

IAT-II TIMETABLE SH23

S. No.	DATE	TIME	SUBJECT
1	20-10-2023 Friday	11:30-12:30	Design & Drawing of Reinforced Concrete Structures
2		3:30-4:30	Advanced Construction Technology
3	23-10-2023 Monday	11:30-12:30	Quantity Survey, Estimation and Valuation
4		3:30-4:30	Solid hazardous waste management
5	25-10-2023 Wednesday	11:30-12:30	Disaster Management and Mitigation Measures

DEPT. EXAM I/C

HOD

PRINCIPAL
TERNA ENGINEERING COLLEGE
Nerul, Navi Mumbai - 400 706



TERNA ENGINEERING COLLEGE, NERUL

Department of Civil Engineering

Academic Year 2023-24 (SH23)



Date: 17th October, 2023

NOTICE

All the students of SE, TE & BE are informed that their IAT-II will be conducted from 20th Oct 2023, 23rd Oct 2023 & 25th Oct 2023. Detailed time table will be displayed on notice board soon.

Exam Co-ordinator

HoD



PRINCIPAL
TERNA ENGINEERING COLLEGE
Nerul, Navi Mumbai - 400 706



TERNA ENGINEERING COLLEGE, NERUL

Department of Civil Engineering

Academic Year 2023-24 (SI123)

Date: 23rd October 2023

NOTICE

All the students of TE & BE are informed that they should submit the Term work on or before 27th October 2023.

As per university of Mumbai guidelines students failed to submit term work will not be allowed to appear in Oral examinations.

Detailed time table of oral exam will be displayed on notice board soon.

Exam Co-ordinator

HOD

PRINCIPAL
TERNA ENGINEERING COLLEGE
Nerul, Navi Mumbai - 400 706



TERNA ENGINEERING COLLEGE, NERUL

Department of Civil Engineering

Academic Year 2023-24 (SI23)

Date: 30th October 2023

NOTICE

All the students of SE are informed that they should submit the Term work on or before 3rd November 2023.

As per university of Mumbai guidelines students failed to submit term work will not be allowed to appear in Oral examinations.

Detailed time table of oral exam will be displayed on notice board soon.

Exam Co-ordinator





PRINCIPAL
TERNA ENGINEERING COLLEGE
Nerul, Navi Mumbai - 400 706



TPCT'S TERNA ENGINEERING COLLEGE
DEPARTMENT OF CIVIL ENGINEERING

SEMESTER -IV

ORAL EXAM TIMETABLE FH24

S. No.	DATE	TIME	SUBJECT
1	22-04-2024 MONDAY	10:00 Onwards	SURVEY
2	23-04-2024 TUESDAY	10:00 Onwards	FM-II
3	24-04-2024 WEDNESDAY	10:00 Onwards	BMCT
4	25-04-2024 THURSDAY	10:00 Onwards	SA
5	30-04-2024 TUESDAY	10:00 Onwards	MINI PROJECT

DEPT. EXAM I/C



HOD

PRINCIPAL
TERNA ENGINEERING COLLEGE
Nerul, Navi Mumbai - 400 706



TPCT's TERNA ENGINEERING COLLEGE
DEPARTMENT OF CIVIL ENGINEERING

SEMESTER -V

KT ORAL EXAM TIMETABLE FH24

S. No.	DATE	TIME	SUBJECT	INTERNAL EXAMINER
1	23-04-2024 TUESDAY	10:00 Onwards	TRCS	VK
2	23-04-2024 TUESDAY	10:00 Onwards	AH	VK
3	25-04-2024 THURSDAY	10:00 Onwards	GE-I	DG
4	26-04-2024 FRIDAY	10:00 Onwards	TRE	RT
5	29-04-2024 MONDAY	10:00 Onwards	MINI PROJECT	DG

DEPT. EXAM I/C

HOD



PRINCIPAL
TERNA ENGINEERING COLLEGE
Nerul, Navi Mumbai - 400 706



TPCT's TERNA ENGINEERING COLLEGE, NERUL.
Department of Civil Engineering
EXTERNAL ORAL EXAM TIME TABLE 2023-24 (SH23)
SE (SEM III)

Sr. No.	SUBJECT	DATE	TIME
1	MOS	04-11-2023	9:30 AM
2	FM-I	06-11-2023	9:30 AM
3	EG	07-11-2023	9:30 AM
4	APDB	08-11-2023	9:30 AM
5	Mini Project- 1A	09-11-2023	9:30 AM

Note: No students will be allowed for external exam without completion of Term Work and Assignments given by respective faculties.

Dept. Exam I/C

HoD



PRINCIPAL
TERNA ENGINEERING COLLEGE
Nerul, Navi Mumbai - 400 706



TPCT's TERNA ENGINEERING COLLEGE, NERUL
Department of Civil Engineering
EXTERNAL ORAL EXAM TIME TABLE 2023-24 (SH23)
TE (SEM V)

Sr. No.	SUBJECT	DATE	TIME
1	TRE	28-10-2023	9:30 AM
2	GE -II	30-10-2023	9:30 AM
3	AH	01-11-2023	9:30 AM
4	Mini Project- 2A	02-11-2023	9:30 AM
5	TRCS	03-11-2023	9:30 AM

Note: No students will be allowed for external exam without completion of Term Work and Assignments given by respective faculties.

Dept. Exam I/C

HoD

PRINCIPAL
TERNA ENGINEERING COLLEGE
NERUL, NEW MUMBAI - 400706



TPCT's TERNA ENGINEERING COLLEGE, NERUL
Department of Civil Engineering
EXTERNAL ORAL EXAM TIME TABLE 2023-24 (SH23)
BE (SEM VII)

Sr. No.	SUBJECT	DATE	TIME
1	DDRCS	30-10-2023	9:30 AM
2	QSEV	31-10-2023	9:30 AM

Note: No students will be allowed for external exam without completion of Term Work and Assignments given by respective faculties.

Dept. Exam I/C

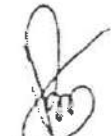
HoD



PRINCIPAL
TERNA ENGINEERING COLLEGE
Nerul, Navi Mumbai - 400 706



t-ina

Terna Engineering College

Department of Civil Engineering

Internal Assessment Test (IAT)-I SH23

Subject: ILOC7017 Disaster Management and Mitigation Measures

Sem: VII

Max. Marks: 20

Duration: 1 Hr

Note: Attempt all the question

Q. no.	Questions	IAT of Marks(20)	BL	CO	PO
Q1	Each question of two marks (solve any three)	6			
1(a)	What is meant by a disaster?	2	1	1	1,7
1(b)	Discuss the direct and indirect effects of disasters.	2	2	1	1,7
1(c)	What is meant by the manmade disasters, discuss any one with an example?	2	1	1	6,12
1(d)	What is meant by the natural disasters, discuss any one with an example?	2	1	1	6, 12
Q2	Solve any one	7			
1	Discuss the importance and principles of disaster management policies	7	2	2,3	6, 7, 12
2.	Discuss the effects of global warming and climate change, on ecology of the earth.	7	2	2,3	6, 7, 12
Q3	Solve any one	7			
1.	Write a short note on Bhopal gas tragedy.	7	4	1	1,12
2.	Explain various possible responsible factors and the effects, in regards to the recent disasters in Northern part of India.	7	4	1	1,12

BL – Bloom's Taxonomy Levels (1- Remembering, 2- Understanding, 3 – Applying, 4 – Analysing, 5 – Evaluating, 6 -Creating)

CO – Course Outcomes

PO – Program Outcomes

The above format is recommended to follow. The Bloom's Level wise analysis is necessary to be included along with paper.



PRINCIPAL
TERNA ENGINEERING COLLEGE
Nerul, Navi Mumbai - 400 706

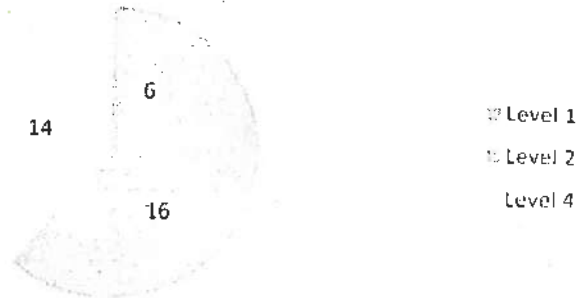

Bloom's Level wise Marks Distribution

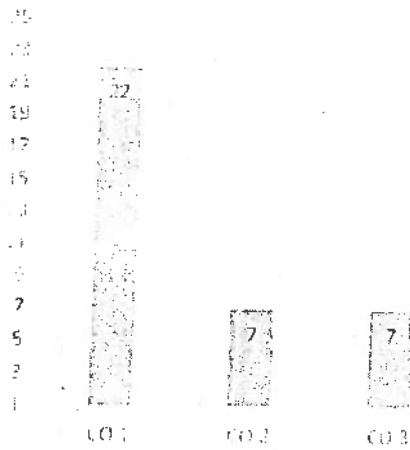

Course Outcome wise Mark Distribution



[Signature]
Subject I/C

[Signature]
Domain Coordinator

[Signature]
IQAC Coordinator

[Signature]
PRINCIPAL
TERNA ENGINEERING COLLEGE
Nerul, Navi Mumbai - 400 706



Terna

Terna Engineering College
Civil Engineering Department

Internal Assessment Test (IAT-II) (SE-23)

Subject: Quantity Survey, Estimation & Valuation

Max. Marks: 20

Sem: VII

Duration: 1 Hr

Note:

Q. no.	Questions	IAT of Marks (20)	BL	CO	PO
Q1	Each question of two marks. Solve any three.	6			
(a)	Write a short note on security deposit.	2	1	5	1,2,3,5,6
(b)	Define following term. 1. Monopoly value 2. Sentimental value	2	1	6	1,2,3,5,6
(c)	Define depreciation & state different methods of calculation of depreciations.	2	1	6	1,2,3,5,6
(d)	Write a short note on BOT Contract.	2	1	5	1,2,3,5,6
Q2	Solve any one	7			
A	A RCC beam 300 x 600 mm and length 5500 mm is reinforced with 3 nos. of 20 mm ϕ main bar placed in one row out of which 3 bars are straight and 2 bar is bent up respectively. In addition to this 2 anchor bars of 12 mm dia. are provided at top, 8 mm ϕ stirrups are provided at 120 mm c/c. The overall cover provided to beam is 25 mm. Calculate total quantity of reinforcement OR	7	5	3	1,2,4,6
B	1. Draft a tender notice for construction of Road having cost 42 Lakh in New Mumbai. Assume suitable data if necessary. 2. A construction equipment was purchase for 5.2 Lakh with an rate of interest of 6.5%. Determine the life of the equipment if annual sinking fund is 30000/-. And salvage value is 60000/-.	4	3	5	1,2,3,5,6
Q3	Solve any one	7			
A	Workout the quantity of following item from a drawing shown in Fig.1 1. Brick masonry in super structure. 2. RCC work in all footing OR	4	4	3	1,2,3,5,6
B	1. A building is newly constructed at the cost of Rs. 22,50,000 on a plot of 600 m ² fix the monthly rent of this property from the following data. Rate of land Rs 120/m ²	3			6

PRINCIPAL
TERNA ENGINEERING COLLEGE
Nerul, Navi Mumbai - 400 706



- Return expected on cost of land = 8%
- Return expected on cost of building = 10%
- Life of building 60 years.
- Rate of interest for sinking fund = 3%
- Maintenance cost = 3% of construction cost.
- Scrap value = 10% of cost of construction.
- Other outgoings = 30% of gross rent.

4	4	6	1,2,3,5,6
3	2	5	1,2,3,5,6

2. Explain the situation when the lowest tenderer are rejected

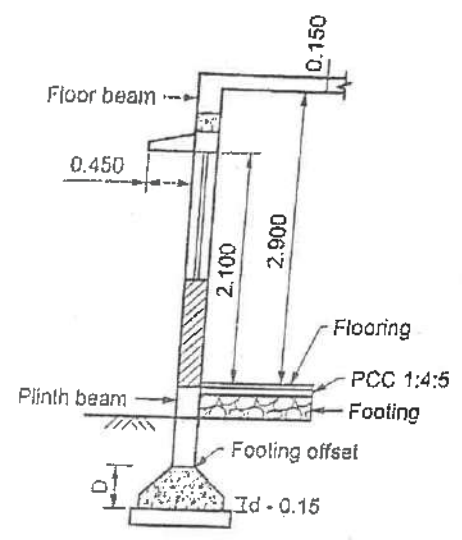
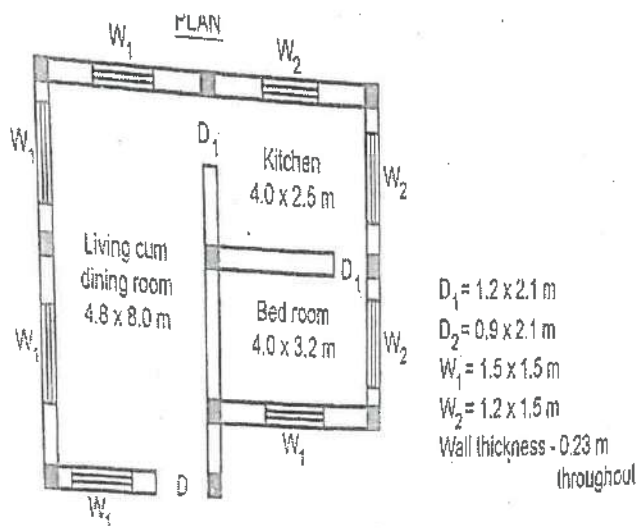

1. Overall size of footing: 1.5 x 1.2 m
2. Size of column: 230 x 380 mm
3. Footing offset near column face: 50 mm
4. Size of beam: 230 x 450 mm.
5. Total Depth of footing: (D): 450 mm
6. Plinth height: 450 mm

BL – Bloom’s Taxonomy Levels (1- Remembering, 2- Understanding, 3 – Applying, 4 – Analysing, 5 – Evaluating, 6 -Creating)
 CO – Course Outcomes
 PO – Program Outcomes

The above format is recommended to follow. The Bloom’s Level wise analysis is necessary to be included along with paper.

PRINCIPAL
TERNA ENGINEERING COLLEGE
 Nerul, Navi Mumbai - 400 706



Bloom's Level wise Marks Distribution

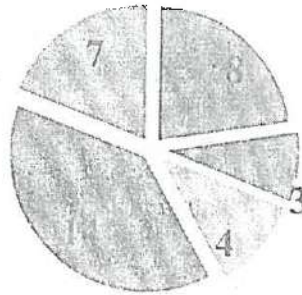

- Level 1
- Level 2
- Level 3
- Level 4
- Level 5

Course Outcome wise Mark Distribution

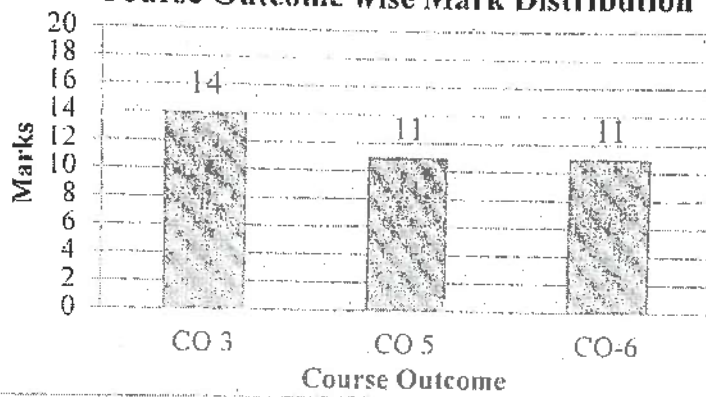

The paper which will be distributed to the students can be only questions and marks. This format is necessary for internal IAT quality assurance and will be audited.

Subject Incharge

Domain Head

IQAC Dept I/C

PRINCIPAL
TERNA ENGINEERING COLLEGE
Nerul, Navi Mumbai - 400 706



TERNA ENGINEERING COLLEGE, NERUL
Department of Civil Engineering

Expert Talk Report
Topic

**GEOTECHNICAL CHALLENGES IN URBAN
INFRASTRUCTURE**

Audience

Students and Faculties of Dept. of Civil Engineering

Speaker

Dr. Dasaka Murthy,

Chairman, IGS Mumbai Chapter and Prof., IIT, Bombay

Venue

Terna Auditorium

Date: 26th Sept. 2023

Time: 2:00 pm to 4:00 pm

Organized by

IGS student chapter, Dept. of Civil Engineering, Terna Engineering College

In association with

IC-ACI, IEI and CESA

terna



PRINCIPAL
TERNA ENGINEERING COLLEGE
Nerul, Navi Mumbai - 400 706



INDEX

Sr No	Particulars	Page No
1	Expert Talk Report	3
2	Invitation Letter	4
3	Profile of the expert member	5
4	Budget	6
5	Photographs	7
6	Feedback	7



PRINCIPAL
TERNA ENGINEERING COLLEGE
Nerul, Navi Mumbai - 400 706



Expert Talk Report

The Indian Geotechnical Society (IGS), student chapter, Department of Civil Engineering, Terna Engineering College organized an Expert talk on "Geotechnical Challenges in Urban Infrastructure" on 26th Sept., 2023 for all students of Civil engineering. The lecture was delivered by Dr. Dasaka Murthy, Professor, IIT Bombay & Chairman, IGS Mumbai Chapter. The scope of Geotechnical Engineering expanded significantly in the last 30 years, and students are exposed to the wide coverage of current trends and exciting professional/research opportunities in geotechnical engineering. There is a need to motivate students to give exposure to careers and opportunities in this area and also develop leadership skills among students which will help them in their career.

This expert talk benefitted the students to enhance their knowledge regarding Geotechnical Engineering and the recent trends in it. A quiz was also conducted by the expert, also students' doubts were been cleared satisfactorily during doubt session.

Student Chapter Coordinator

HOD

PRINCIPAL
TERNA ENGINEERING COLLEGE
Nerul, Navi Mumbai - 400 706



Speaker Profile



Name : Dr. Dasaka Murthy

Educational Qualification Details:

Ph.D. in Civil Engineering, Indian Institute of Science, Bangalore, 2006

M.Tech. in Civil Engineering, Indian Institute of Technology Madras, Chennai, 2001

B.Tech. in Civil Engineering, JNTU College of Engineering, Hyderabad, 1998

Diploma in Civil Engineering, SMVM Polytechnic, Tanjore, Andhra Pradesh, 1994

Research Areas :

Retaining Walls and Earth Pressure Reduction, BE Walls, Ground Improvement, Shallow and Deep Foundations, Deep Excavation Supporting Systems, Trenching, Groundmass

Awards and Recognitions :

- Member, Board of Studies, B.Tech. (Civil Engg.), NIT Warangal
- Member, Board of Studies, M.Tech. (GIE), NIT Warangal
- Member, Academic Council, College of Engineering Pune, Since June 2022
- Member, Soil and Foundation Engineering Sectional Committee, CID-43, of Bureau of Indian Standards
- Secretary, TC-302 (Forensic Geotechnical Engineering) of International Society for Soil Mechanics and Geotechnical Engineering (ISSMGE), since 2019
- Chairman, Mumbai Chapter of Indian Geotechnical Society, Since 2021
- Secretary, Mumbai Chapter of Indian Geotechnical Society, Since 2019-21.
- IGS-AIMIL Biennial Award for the best paper on instrumentation published in Indian Geotechnical Journal for the year 2020.
- Springer Nature Best Paper Award in the Category Geosynthetics and Reinforced Soil Structures Indian Geotechnical Society Visakhapatnam, December, 2020.
- Indian Geotechnical Society - J. Rao-Y.R. Phull Biennial Award for the best paper on "Effect of Uncertainties in the Field Load Testing on the Observed Load-Settlement Response", for the year 2016.
- Member, Executive Committee, Indian Geotechnical Society, New Delhi, 2010-11.
- Fast track Young Scientist research fellowship, Department of Science and Technology, Government of India, 2009.
- Indian Geotechnical Society - Shri B.N. Gupta, Madras biennial award for the best paper on "New approaches and techniques for analysis and design of shallow foundation" for the year 2002-2003.

PRINCIPAL
TERNA ENGINEERING COLLEGE
Nerul, Navi Mumbai - 400 706



TERNA PUBLIC CHARITABLE TRUST'S
TERNA ENGINEERING COLLEGE, NERUL
Department of Civil Engineering

Date: 30th September 2023

To,

The Principal,

Terna Engineering College,
Nerul, Navi Mumbai.

Subject: Bill settlement for Inauguration of "Indian Geotechnical Society's student chapter"

Respected Sir,

Department of Civil Engineering received Rs. 3200/- for the inauguration of student chapter of Indian Geotechnical Society (IGS).

Here are the details of expenditure for the same

Budget Details		
Sr. No.	Particulars	Expenditure (Rs.)
1	Snacks for guest	1340/-
2	Water bottles	340/-
3	Miscellaneous	670/-
4	Banner	850/-
Total Rs. Two Thousand Four Hundred Only		3200/-

Thank You

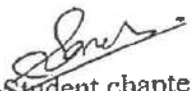
- Student chapter Coordinator

Head of Department

PRINCIPAL
TERNA ENGINEERING COLLEGE
Nerul, Navi Mumbai - 400 706



Terna Engineering College, Nerul, Navi Mumbai

Advance Settlement Form

From Sonali Vikrant Baviskar

Designation Asst. Prof. Dept. Civil Engg.

To,
The Principal,
Terna Engineering College,
Nerul, Navi Mumbai.

Through : Head of Dept.

Respected Sir,

I had taken an advance of Rs. 3200/- (Rupees Three
Thousand Two Hundred Only only)

in connection with ICs student chapter inauguration

as per the direction of my superior officer Mr./Prof. Dr. Poojanka Salunkhe

I had of Dept./Principal on 26th Sept 2023 I am now submitting the settlement of

the same. The total expenditure was Rs. 3208/- (Rupees

Three Thousand Two Hundred Eighty + I am refunding the balance of

Rs. — The deficit Rs. — shall be refunded by the college to me.

Kindly approve the same.

Encl : 1. Bills

2. _____

Sonali
Yours Sincerely

Date 30/10/2023
30th Oct. 2023

* Strike out whichever is not applicable.

PRINCIPAL
TERNA ENGINEERING COLLEGE
Nerul, Navi Mumbai - 400 706



P.T.O

Remarks by Superior Officer

The claim and settlement of above staff working under me is verified and found to be in order. So recommended for acceptance / refund

Superior officer

Head of Dept.

Management Coordinator

Report & clearance from EST/A/c. sect.

The settlement submitted is verified and found to be in order as per the rules of the college/Trist. Hence cleared for payment.

O.S/ Registrar

Accountant

Approval

- Pl. forward this settlement to CEO for approval.
- Approved Settlement. Pl. accept the balance amount.
- Approved settlement : Pl. refund the deficit amount to the staff.

(PRINCIPAL)

N.B.

The settlement form shall be directly submitted to the account section who after verification shall put up the same to the Principal for approval.

PRINCIPAL
VERNA ENGINEERING COLLEGE
Nerul, Navi Mumbai - 400 706



Photographs



TPCT'S
TERNA ENGINEERING COLLEGE, NERUL
DEPARTMENT OF CIVIL ENGINEERING

ORGANISES

INAUGURATION CEREMONY OF
INDIAN GEOTECHNICAL SOCIETY
STUDENT CHAPTER

GUESTS OF HONOUR



DR. DINESH KULKARNI
DIRECTOR OF RESEARCH & DEVELOPMENT
IIT BOMBAY



DR. VISHAL TRIVEDI
DIRECTOR OF RESEARCH & DEVELOPMENT
IIT BOMBAY



DR. ANISH KUMAR
DIRECTOR OF RESEARCH & DEVELOPMENT
IIT BOMBAY



DR. ANISH KUMAR
DIRECTOR OF RESEARCH & DEVELOPMENT
IIT BOMBAY



PRINCIPAL
TERNA ENGINEERING COLLEGE
Nerul, Navi Mumbai - 400 706



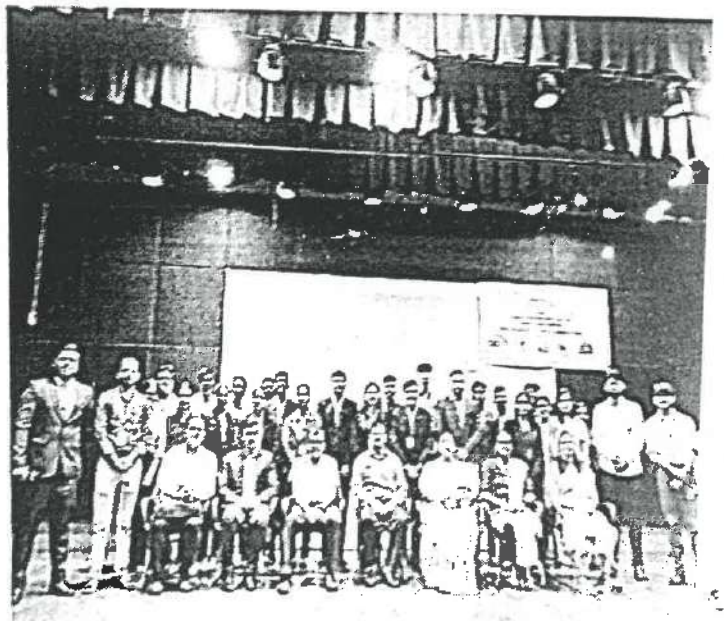
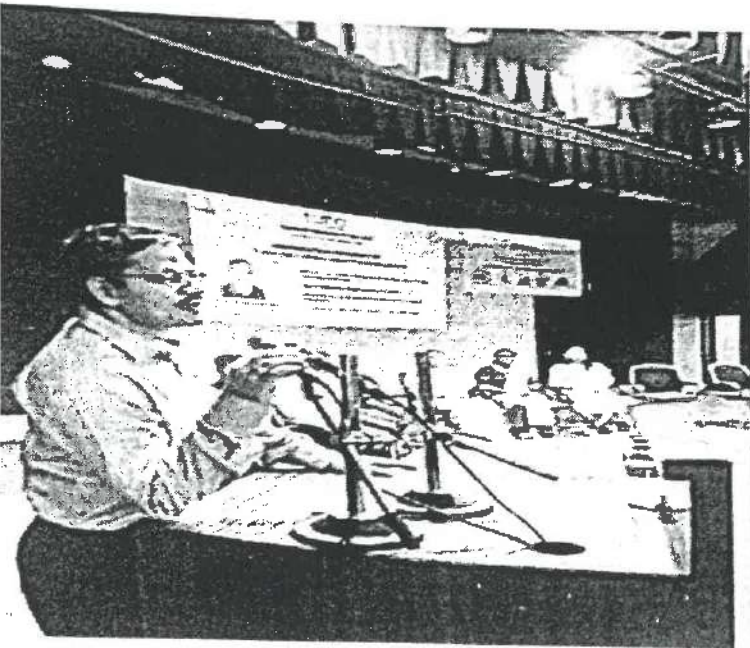
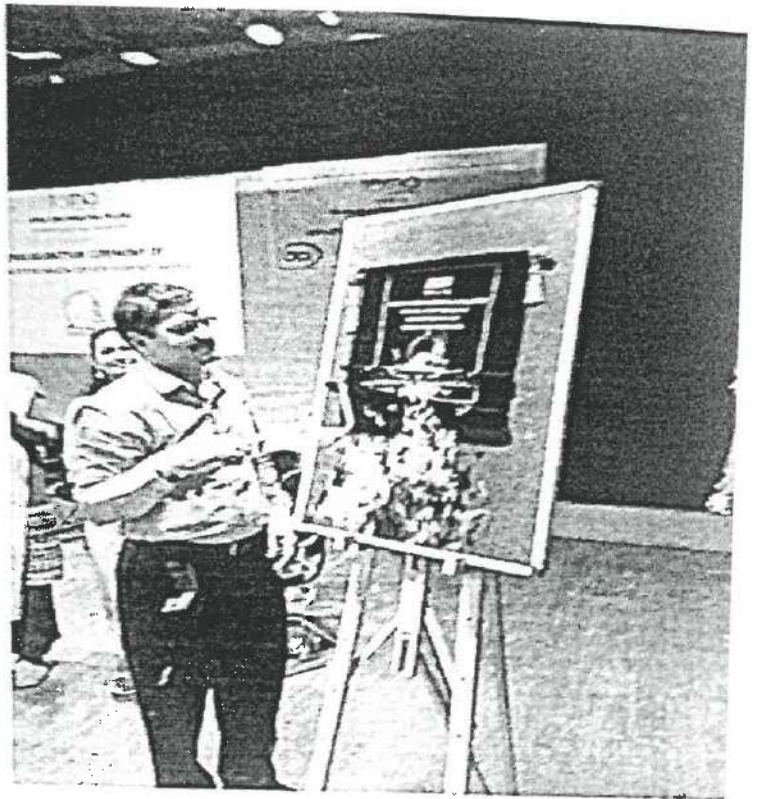



PRINCIPAL
TERNA ENGINEERING COLLEGE
Nerul, Navi Mumbai - 400 706



Feedback

The subject matter presented effectively

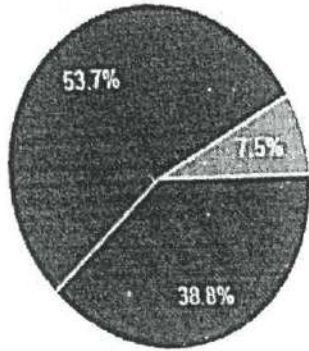
67 responses



- Strongly agree
- Agree
- Neutral
- Disagree

The speed of expert talk was satisfactory

67 responses

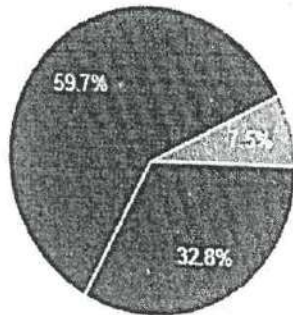

- Strongly agree
- Agree
- Neutral
- Disagree

Overall how you rate the expert talk

67 responses

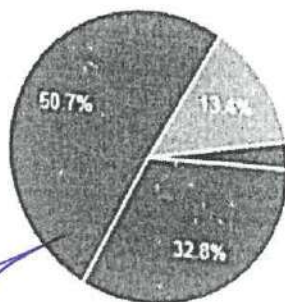

- Excellent
- Very good
- good
- Fair

PRINCIPAL
TERNA ENGINEERING COLLEGE
Nerul, Navi Mumbai - 400 706



76103143

SH23 : FEV-01 01.18.8.23

Terna Engineering College, Nerul, Navi Mumbai
 Department - CIVIL ENGINEERING
 Attendance Sheet

Date & Time:-

Sett - III

not [IGS opening]

Sl. No.	Student Name	Sign	Roll	ID No.	Student Name	Sign
A1	KARHADKAR ANANYA SHREENAND	<i>Ananya</i>	A38	TU7F2122043	MUNDHE ROHANI	<i>Rohani</i>
A2	WHATRE TEJAS CHANDRAHAS	<i>Tejas</i>			Siddhardh Khator	<i>Siddhardh</i>
A3	JUHDARE SUJAL PRAVIN	<i>Sujal</i>			Himanshu Sangle	<i>Himanshu</i>
A4	SHAIKH SAHIL RAJU				Prem Nethke	<i>Prem</i>
A5	JADHAV SIDDHESH SANTOSH				Saurabh Patil	<i>Saurabh</i>
A6	THAKUR HIMANSHU DEEPAK				Amit	<i>Amit</i>
A7	JADHAV YASHI DEEPAK				An Yashika	<i>An Yashika</i>
A8	MAGARE DIVYAN PRAKASH				Pratik Gurav	<i>Pratik</i>
A9	PATIL SAKSHI SUNIL				Pravin Sade	<i>Pravin</i>
A10	ELEGAM SARVESH POSAMALLU				Jayesh Bhat	<i>Jayesh</i>
A11	PATHOD KARTIK NAMDEV				Vorunaj chavan	<i>Vorunaj</i>
A12	PAJBHOJ ANISH ANIL	<i>Anish</i>			Tyupti Shinde	<i>Tyupti</i>
A13	KADACHANE SHARWARI SAGAR				Prerna Prash	<i>Prerna</i>
A14	KUMBHAR VINIT KISHOR				Takale Rupali	<i>Rupali</i>
A15	DESAI ANIRUDDHA AJIT				Rucha Shinde	<i>Rucha</i>
A16	VALVI ANSHJAY SURESH				Komal Trangle	<i>Komal</i>
A17	THAKUR JEET SANJEEV	<i>Jeet</i>			Anisha Koli	<i>Anisha</i>
A18	MALAP AYUSH BHAGWAN	<i>Ayush</i>			Shantanu Patil	<i>Shantanu</i>
A19	PALVE PRATAP SHAMRAO				Chaitanya Langade	<i>Chaitanya</i>
A20	SHARMA VINAY KUMAR	<i>Vinay</i>			RAJESH GURPESHI	<i>Rajesh</i>
A21	DESHMUKH PRATIK PRATAP				KSHITIJ TELHI	<i>Kshiti</i>
A22	CHAVAN MANASVI RATNAKAR				Bhagyashree Kamble	<i>Bhagyashree</i>
A23	SHAH SOHAM SANDIP				Bhramini Shirke	<i>Bhramini</i>
A24	KAMBLE KAPILA SARJERAO				Sanskarti Madal	<i>Sanskarti</i>
A25	SINGH KARAN BIJAYENDRAPRATAP				Sakshi Kulkarni	<i>Sakshi</i>
A26	SANAP PRITESH RAJARAM				Vaibhavi Chavhan	<i>Vaibhavi</i>
A27	MAKHIIJA MOHNISH SANDEEP	<i>Mohish</i>			Shubham Patil	<i>Shubham</i>
A28	RAJPUT SAHIL KIRTI					
A29	PARGHANE ABHAY DILIP	<i>Abhay</i>				
A30	PARKAR TANVI VINAYAK					
A31	THAKUR SAHIL SUDHAKAR					
A32	PATIL AMRUT ARUN					
A33	BANDENSHI PRATIBHA					
A34	KURHADE CHAITALI	<i>Chaitali</i>				
A35	PASHTE VIRAJ RAVINDRA					
A36	GHADAGE PREM PRATAP					
A37	KUMTHIKAR AADITYA SANJAY					

Sign & Date:

Datches

[Signature]

PRINCIPAL
 TERNA ENGINEERING COLLEGE
 Nerul, Navi Mumbai - 400 706



TE 1E

SH23 : REV-00 Dt.15.7.23

Terna Engineering College, Nerul, Navi Mumbai

Department :- CIVIL ENGINEERING

Attendance Sheet

Teacher :- IGS opening		Date & Time :-				Div :- A	Sem :- V
Roll No.	ID No.	Student Name	Sign	Roll No.	ID No.	Student Name	Sign
A1	TU7F2122001	TAMBDE KSHITIJ		A40	TU7S2223003	CHIRLEKAR AARYAN ANIL	[Signature]
A2	TU7F2122002	MHATRE JATIN		A41	TU7S2223006	MANKUMBARE SOHAM M	
A3	TU7F2122003	CHIKANE ATHARVA		A42	TU7S2223005	SONAWANE KHUSHAL B	[Signature]
A4	TU7F2122004	SHINDE MAYUR BABURAV		A43	TU7S2223004	AMBHORE ARYAN ASHOK	[Signature]
A5	TU7F2122005	CHOKALE HARSHAL		A44	TU7S2223007	KHAN MEHTAB ALAM M	[Signature]
A6	TU7F2122006	SHINDE AADITYA		A45	TU7S2223008	GHADI ANISH PRADEEP	
A7	TU7F2122007	KOLTE PRIYESH		A46	TU7S2223009	PATIL KARTIK KIRAN	[Signature]
A8	TU7F2122009	CHINARATHOD VINOD	[Signature]	A47	TU7S2223010	KENI VAIBHAVEE SUBODH	[Signature]
A9	TU7F2122010	GHONGE VIRAJ		A48	TU7S2223011	BOWLEKAR SHAILESH S	
A10	TU7F2122011	INGLE VIVEK SUDHAKAR	[Signature]	A49	TU7S2223012	PALEKAR PRANAY ANIL	
A11	TU7F2122012	MHATRE SAI		A50	TU7S2223013	LAD AMEY MAHADEV	[Signature]
A12	TU7F2122013	DESHMUKH SHRADDHA SATISH		A51	TU7S2223014	DHUMAL GAURI SANJAY	[Signature]
A13	TU7F2122015	BODAKE JANARDAN	[Signature]	A52	TU7S2223015	JADHAV SHRIYA VIVEK	[Signature]
A14	TU7F2122016	BHOSALE MAYUR		A53	TU7S2223016	PATIL SOHAM VINOD	[Signature]
A15	TU7F2122017	MUMBAIKAR VIPUL	[Signature]	A54	TU7S2223017	BHUJBAL ARYAN C	[Signature]
A16	TU7F2122018	PADGHAN SPARSHA VILAS		A55	TU7S2223018	SINGH AYUSH JITENDRA	[Signature]
A17	TU7F2122019	KOLEKAR MAHESH		A56	TU7S2223019	GHANGALE ANAMAY UTTAM	[Signature]
A18	TU7F2122026	OWALEKAR GAURAV		A57	TU7S2223020	DOMBARE VAISHNVI LAXMAN	[Signature]
A19	TU7F2122025	MANGLE MANAV		A58	TU7S2223021	RANSHUR SAKSHI RAJU	[Signature]
A20	TU7F2122024	KHANDAGALE ANOSH		A59	TU7S2223022	GHAIKAT PRAHJALI M	
A21	TU7F2122023	PATIL CHINMAY	[Signature]	A60	TU7S2223023	RATHOD SHEHAL SHIVAJI	
A22	TU7F2122022	AHIRWAR SHUBHAM		A61	TU7S2223024	KONDIKIRE MAYUR DILIP	[Signature]
A23	TU7F2122021	SHINDE NBERAJ		A62	TU7S2223025	YEDURKAR SEJAL RAMDAS	[Signature]
A24	TU7F2122020	MAGAR BHAIKAV		A63	TU7S2223026	CHORAGE AKASH AKARAM	
A25	TU7F2122027	ANDHARE KAUSHAL ...		A64	TU7S2223027	CHAUDHARI ATHARVA	
A26	TU7F2122028	TAMBE VEDANT	[Signature]	A65	TU7S2223028	RAUT RUTUJA TUKARAM	[Signature]
A27	TU7F2122029	ROUNDHAL VIRAJ		A66	TU7S2223029	MORE VINEET MILIND	[Signature]
A28	TU7F2122030	CAVIT GAJENDRA		A67	TU7S2223030	KALE ATHARVA AMBADAS	[Signature]
A29	TU7F2122031	KAMBLE TANMAY		A68	TU7S2223031	SHINDE SAHIL SANJAY	[Signature]
A30	TU7F2122032	LUDAL SWAPNEEL	[Signature]	A69	TU7S2223032	TAMBE ROHIT BABAN	[Signature]
A31	TU7F2122033	DHONE MAYUR	[Signature]	A70	TU7S2223033	BHADANGE DHIRAJ M	
A32	TU7F2122034	KARBHARI NIKHIL	[Signature]	A71	TU7S2223034	GAOKAR SANIKA DATTARAM	[Signature]
A33	TU7F2122036	SHIRSAT SHRUTI		A72	TU7S2223035	DHUMALE ATHARVA SANTOSH	
A34	TU7F2122039	KHARATMOL UJWAL PANDURANG					
A35	TU7F2122040	HANDEKAR AISHWARYA					
A36	TU7F2122042	WALHEKAR PRACHI					
A37	TU7F2122044	KAMBLE ROHAN					
A38	TU7S2223001	SHINDE HARSHI SANTOSH	[Signature]				
A39	TU7S2223002	SHINDE AMEY UTTAM					

Sign & Date :-

Batches

PRINCIPAL
TERNA ENGINEERING COLLEGE
Nerul, Navi Mumbai - 400 706



Teacher :-				Date & Time :-			
ID No.	Student Name	Sign	Roll	ID No.	Student Name	Sign	Div :- A
A1	TU7F2021001	GHOLAP VAIBHAV LAHU	<i>[Signature]</i>	A42	TU7F2021047	KADAM RIHITK PRAVRI	
A2	TU7F2021002	BHOIR SANIKA SADANAND	<i>[Signature]</i>	A43	TU7F2021040	GONDKE KOMALS	
A3	TU7F2021003	GAWADE SAURABH KAILAS		A44	TU7F2021049	KHARAT TANISHQ SUDHAKAR	
A4	TU7F2021004	SHAHASANE ADITYA PRAVIN		A45	TU7F2021052	KHANDEKAR MANSI DILIP	
A5	TU7F2021006	WALANJ PRATIK SANTOSH	<i>[Signature]</i>	A46	TU7F2021053	PATIL TANISHQ SOMNATH	
A6	TU7F2021005	MUKHERJEE PRANJAL PARIJAT M		A47	TU7F2021028	HOTKAR AKSHATA JAYSING	
A7	TU7F2021007	KILLEDAR ANURUP ANIL		A48	TU7F2021026	MAHAADIK SAHIL RAJESH	
A8	TU7F2021008	MHATRE SHARV SANTOSH	<i>[Signature]</i>	A49	TU7F2021027	SINGH SAHIL DEEPAJ	
A9	TU7F2021009	KHEDKAR PRANAV PRAVIN	<i>[Signature]</i>	A50	TU7F2021025	PATEL PALASH DIPEH	<i>[Signature]</i>
A10	TU7F2021010	PATIL SAHIL RAVINDRA		A51	TU7S2122001	DONGRE HRISHIKESH	
A11	TU7F2021011	VINOY VISMAY LUKOSE		A52	TU7S2122002	DUDUKA BRIJESH	
A12	TU7F2021012	WAGHMARE NILESH BABURAO		A53	TU7S2122003	JADHAV ADITYA	
A13	TU7F2021013	MOHITE RUSHIKESH JALINDER		A54	TU7S2122004	LAWANE KESHAR	
A14	TU7F2021014	MALI SRUSHTI SHIVAJI		A55	TU7S2122005	BEDEKAR ROHIT	
A15	TU7F2021015	SURYAWANSHI TEJAS DILIP		A56	TU7S2122007	PAWAR SAHIL	
A16	TU7F2021016	PATIL SUMIT DINESH		A57	TU7S2122008	WAYAL SAHIL	
A17	TU7F2021017	BHUSARA DIGVIJAY DASHRATH	<i>[Signature]</i>	A58	TU7S2122006	PARAB ROHAN RAJAN	
A18	TU7F2021018	GAWALI PRATHAMESH PRADEEP		A59	TU7S2122009	SAWANT KRUTIKA	
A19	TU7F2021019	CHAUDHARI HASMITA GANGA	<i>[Signature]</i>	A60	TU7S2122010	POMENDKAR SHIVANI	<i>[Signature]</i>
A20	TU7F2021020	BHUSARA ANJALI SUNIL		A61	TU7S2122011	NAGOYANNEKAR ABHAY	
A21	TU7F2021021	BHOSALE YASH SANJAY		A62	TU7S2122012	THIKADE MILIND JAHU	
A22	TU7F2021024	KOPPULA ASHOK SATISH		A63	TU7S2122013	DUBEY SATYAJEET	
A23	TU7F2021022	AMBRE ANURAG SANJAY		A64	TU7S2122014	SIDDAMAL KARTIK	<i>[Signature]</i>
A24	TU7F2021029	CHOUGULE PARTH VINOD		A65	TU7S2122015	MALVANI YOGESH	<i>[Signature]</i>
A25	TU7F2021030	RAJPUT UDAYRAJSING J		A66	TU7S2122017	PAWAR TEJASHREE	<i>[Signature]</i>
A26	TU7F2021031	GMWARE SAMBODH SHRIKANT		A67	TU7S2122018	GAIKAR KAJAL	
A27	TU7F2021032	DABHADE VIJAY SANJAY		A68	TU7S2122019	GHARAT SIDDHI	
A28	TU7F2021033	PRASAD SHUBHAM SURESHKUMAR		A69	TU7S2122020	PHADTARE SHUBHANGI	
A29	TU7F2021034	KEDARI ADITYA MANGESH		A70	TU7S2122021	PANPALIYA KAUSTUBH	
A30	TU7F2021035	CHAVAN AISHWARYA PATTESING	<i>[Signature]</i>	A71	TU7S2122022	CHAVAN SHIVETA	
A31	TU7F2021036	MANE SAKSHI RAJU		A72	TU7S2122023	MATEKAR ROHIT	
A32	TU7F2021037	KOLI SAGARIKA NITIN		A73	TU7S2122024	GAIKWAD PRATIK	
A33	TU7F2021038	BADGUJAR KALPESH RAJENDRA	<i>[Signature]</i>	A74	TU7S2122025	TADVI SHOAIB	
A34	TU7F2021039	CHAKOR SHUBHAM RAMKRUSHN		A75	TU7S2122026	JADHAV SAKSHI SADASHIV	
A35	TU7F2021040	PATIL DHANSHREE VIKAS		A76	TU7F1920030	KASBE DHANANJAY M	
A36	TU7F2021042	DHANSAY ZAID ZAFARULLAH					
A37	TU7F2021043	MHATRE SAHIL ANANTA					
A38	TU7F2021041	SINGH ANKIT RAJ ASHOK	<i>[Signature]</i>				
A39	TU7F2021044	PATIL AMAN RAVINDRA					
A40	TU7F2021045	LOKE NIMISH GANGARAM					
A41	TU7F2021046	SHELKE ROHIT SHRIMANT					

Sign & Date :-
Batches

PRINCIPAL
TERNA ENGINEERING COLLEGE
Nerul, Navi Mumbai - 400 706



TERNA ENGINEERING COLLEGE, NERUL
Department of Civil Engineering

Expert Talk Report
Topic

“Effect of Admixture on Properties of Concrete”

Audience

S.E. & TE Civil Engineering Students
and
Faculties of Civil Engineering Dept.

Speaker

Ms. Pranjali Takwale,
Engineer Technical Supports,
Krishna Conchem Product PVT LTD
New Mumbai.

Venue

Room No- 211

Date

10th April, 2024

Time

1.30 pm to 4.30 pm

Organized by

R&D Cell, Dept. of Civil Engineering, Terna Engineering College

In association with

ACI, IEI, IGS and CESA

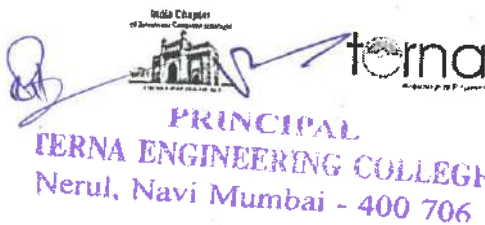

INDEX

Sr No	Particulars	Page No
1	Expert Talk Report	3
2	Annexure I (Invitation Letter)	4
3	Annexure II (Details of Expert talk)	5
4	Annexure III (Photographs)	6
5	Annexure IV (Appreciation Letter)	11
6	Annexure V (Feedback)	12
7	Annexure VI (Attendance)	14

PRINCIPAL
TERNA ENGINEERING COLLEGE
Nerul, Navi Mumbai - 400 706



Expert Talk Report

The R&D cell of the Civil Department of Terna Engineering College organized an Expert talk on "Effect of Admixture on Properties of Concrete" on 10th April 2024 for S.E. & T.E. Civil engineering students. The lecture was delivered by Ms. Pranjali Takwale, Engineer Technical Support, Krishna Conchem Product Pvt Ltd. Navi Mumbai.

This expert lecture is required for the students to enhance their knowledge about different kinds of admixtures & their function in improving the quality of concrete. As this advanced techniques not been mentioned in curriculum in detail, so expert lecture needs to be organized.

This expert talk benefitted the students to understand the basic concept of using admixture in concrete & its function to improve the quality of concrete. A doubt clearing session was also organized with student & expertise.

Prof. Pradip Sonawane
R & D Coordinator

Dr. Priyanka Salunkhe
HOD

PRINCIPAL
TERNA ENGINEERING COLLEGE
Nerul, Navi Mumbai - 400 706



TERNA PUBLIC CHARITABLE TRUST'S
TERNA ENGINEERING COLLEGE

(Approved by AICTE & Affiliated to University of Mumbai)

Plot No. 12, Sector 22, Opposite Railway Station, Nerul (W), Navi Mumbai- 400706. Ph. +91 22 61115444, Fax No.+91 22 61115400
Web : <https://ternaengg.ac.in/>

Date: 27th March 2024

To,
Miss. Pranjali Takwale,
Engineer Technical Supports,
Krishna Conchem Pvt. Ltd.

Subject: Invitation for Expert talk on "Effect of Admixture on Properties of Concrete".

Respected Madam,

On the behalf of Civil Engineering Department, Terna Engineering College, Nerul, Navi Mumbai, we are very pleased to have the honor of inviting you to deliver expert talk in our department. This talk is organized by Civil Department in association with student chapter of Institution of Engineers India (IEI), India Chapter of American Concrete Institute (IC-ACI), Civil Engineering Student Association (CESA) and Indian Geotechnical Society (IGS).

As per telephonic discussion, this talk is scheduled on 10th April 2024 at 2.00 Pm. This session will be attend by student & staff from Civil department. It will be benefited to our student to gain knowledge about different admixture and its effect on properties of concrete.

We are looking forward to hearing from you.

Thanking You

Prof. Pradip Senawane

R & D Coordinator

PRINCIPAL
TERNA ENGINEERING COLLEGE
Nerul, Navi Mumbai - 400 706



Dr. Priyanka Salunkhe

HEAD
DEPT. OF CIVIL ENGG.
TERNA ENGG.COLLEGE
NERUL, NAVI MUMBAI

Details of Expert Talk



TERNA ENGINEERING COLLEGE

Nerul, Navi Mumbai, Maharashtra-400706

R & D cell, Dept. of Civil Engineering.

Is organizing an

Expert Talk

On

Effect of Admixture on Properties of concrete

By



Ms. PRANJALI TAKWALE

Engineer Technical Support
Krishna Conchem Products Pvt. Ltd.

Date : 10 April, 2024

Time : 2:00 pm to 3:30 pm

Venue : Room No 211

In Association Wjth



IEI



IC - ACI



CESA



IGS

PRINCIPAL
TERNA ENGINEERING COLLEGE
Nerul, Navi Mumbai - 400 706





Pranjali Takwale

Designation- Engineer Technical Support

Education – B.E Civil (Mumbai University)

Description-

Working with Krishna Conchem Products Pvt Ltd from last 4.5 years for handling below responsibilities:

- Technical support to pan India marketing team in terms of material specification, rate analysis, tendering, method statement and BOQ.
- Creating branding tools through content writing for literature, leaflets, flyshects and subsequent artwork for respective packaging.
- Activities for the compliance to product approvals and accreditation for various government organisations including- BIS, DSIR, MES, NACE, CIDCO, etc
- Conducting Awareness programs like Corrosion Week, Entrepreneurship Development program, Fiber Wrapping Workshops, IIT Fest, etc
- Technical Training to marketing team and various customer segments like- Contractor Builders, Engineers on Material Selection, Usage and benefits.
- Rendering technical correspondence to R&D regarding numerous short term and long term test for Effectiveness of Construction Chemicals.
- Looking after Technical Presentation in Educational Institute as a Knowledge sharing exercise about construction chemicals to budding engineers.
- Preparation of technical documents such as Material test certificate, Material safety datasheet and liaisoning with manufacturing units for the same.
- Documentation of marketing tools such as Case Histories, AVs, User guidelines and presentation.
- Participated in International Exhibition in Nepal for introducing Krishna Conchem Products- Construction chemicals.
- Representing & Introducing our company technical offering to foreign –Nepal & Dubai clients

PRINCIPAL
TERNA ENGINEERING COLLEGE
Nerul, Navi Mumbai - 400 706



Photographs of Expert Talk

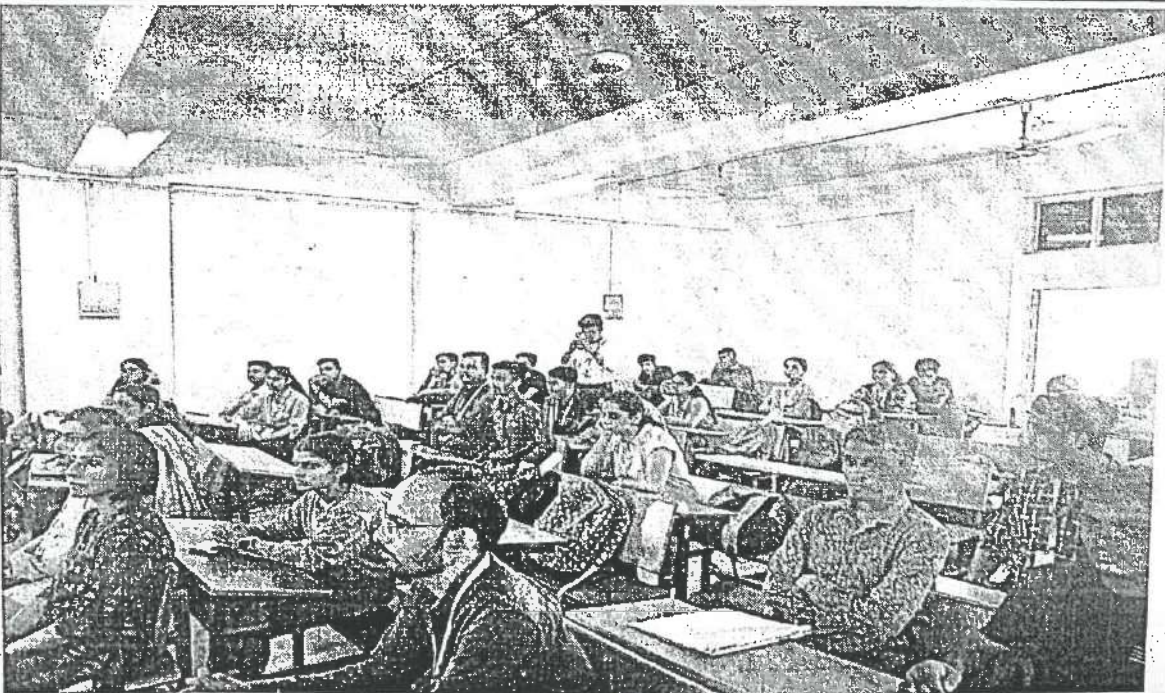
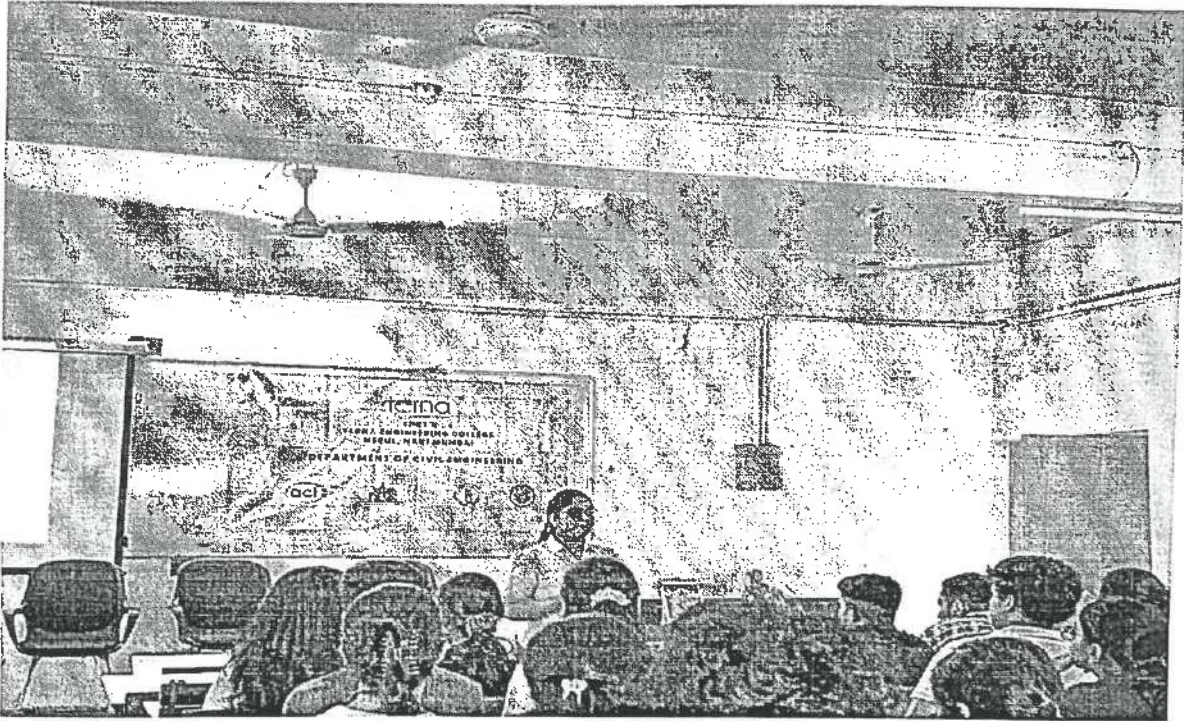

PRINCIPAL
TERNA ENGINEERING COLLEGE
Nerul, Navi Mumbai - 400 706



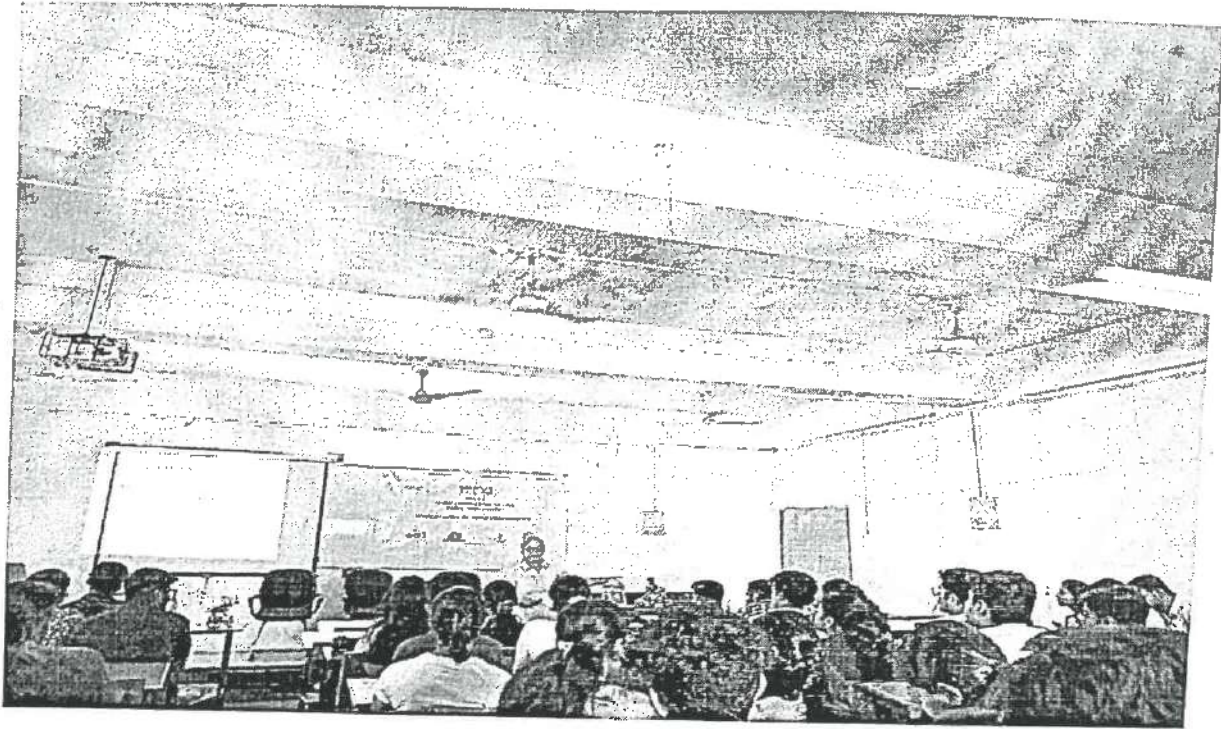



PRINCIPAL
TERNA ENGINEERING COLLEGE
Nerul, Navi Mumbai - 400 706



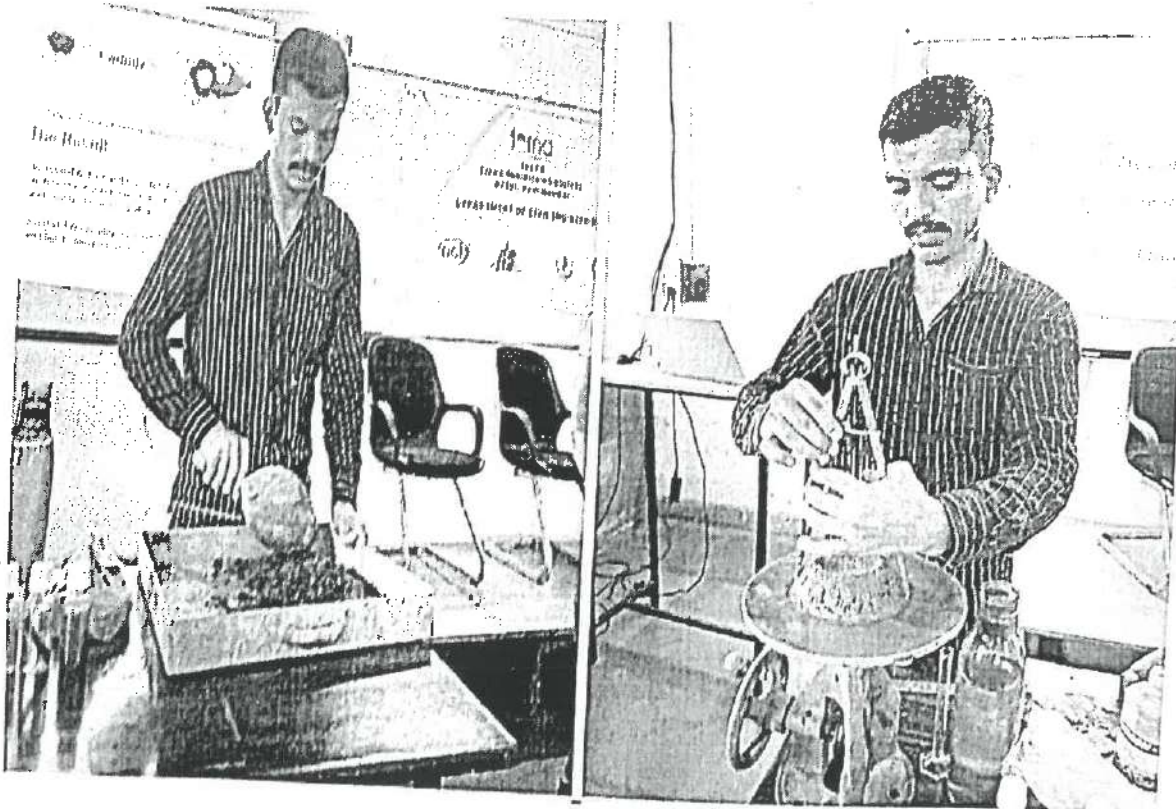
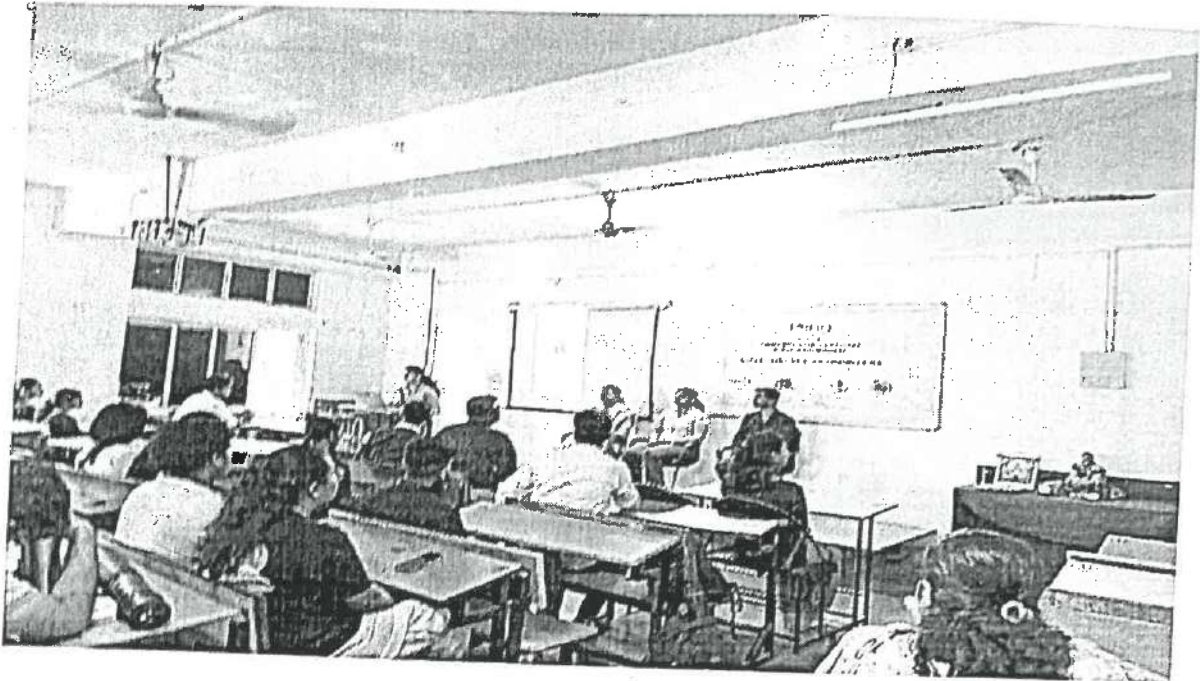



PRINCIPAL
TERNA ENGINEERING COLLEGE
Nerul, Navi Mumbai - 400 706







PRINCIPAL
TPCT'S ENGINEERING COLLEGE
Nerul, Navi Mumbai - 400 706



TERNA PUBLIC CHARITABLE TRUST'S
TERNA ENGINEERING COLLEGE

(Approved by AICTE & Affiliated to University of Mumbai)

Plot No. 12, Sector 22, Opposite Railway Station, Nerul (W), Navi Mumbai- 400706. Ph. +91 22 61115444,

Fax No. +91 22 61115400 Web : <https://ternanog.ac.in/>

Date: 10th April 2024

LETTER OF APPRECIATION

To.

Miss. Pranjali Takwale.

Engineer Technical Supports,

Krishna Conchem Pvt. Ltd.

Respected Madam,

We would like to thank you on behalf of Department of Civil Engineering, Terna Engineering College, Nerul, Navi Mumbai, for the expert talk on "Effect of Admixture on Properties of Concrete

It was highly beneficial to our students to gain knowledge about different admixtures, its effect on properties of fresh and hardened concrete through some hands on training during session.

We are grateful to you and appreciate your valuable time and efforts in delivering the Expert speak. We anticipate the same in the future.

Received.

PRINCIPAL
TERNA ENGINEERING COLLEGE
Nerul, Navi Mumbai - 400 706

Dr. Priyanka Salmulhe
HEAD
DEPT. OF CIVIL ENGG
TERNA ENGG. COLLEGE
NERUL, NAVI MUMBAI



Feedback

Feedback Link:

<https://forms.gle/4Mptbxe26XFP6arf7>

The subject matter presented effectively

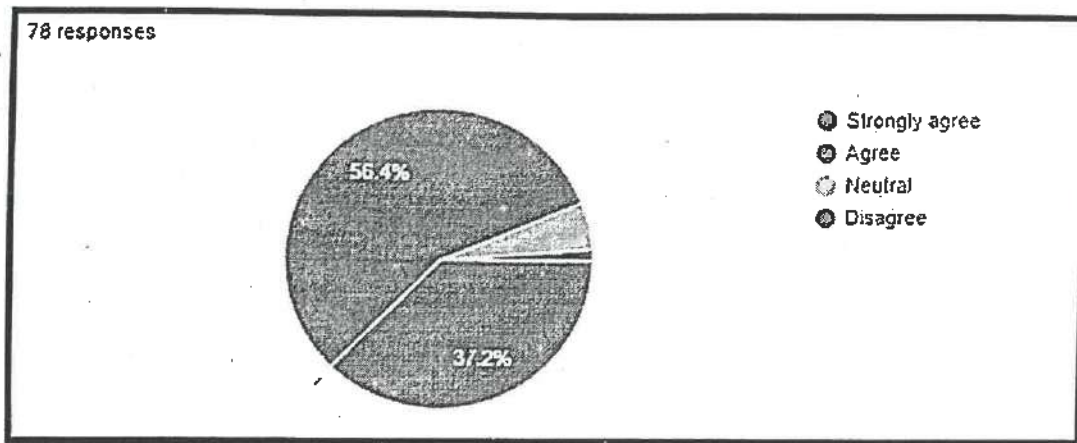

The speed of expert talk was satisfactory

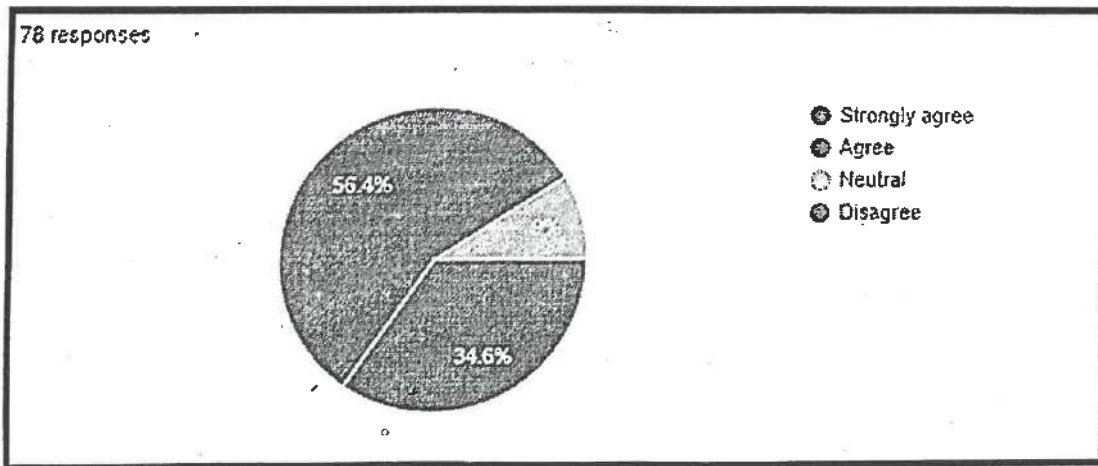



PRINCIPAL
FERNA ENGINEERING COLLEGE
Nerul, Navi Mumbai - 400 706

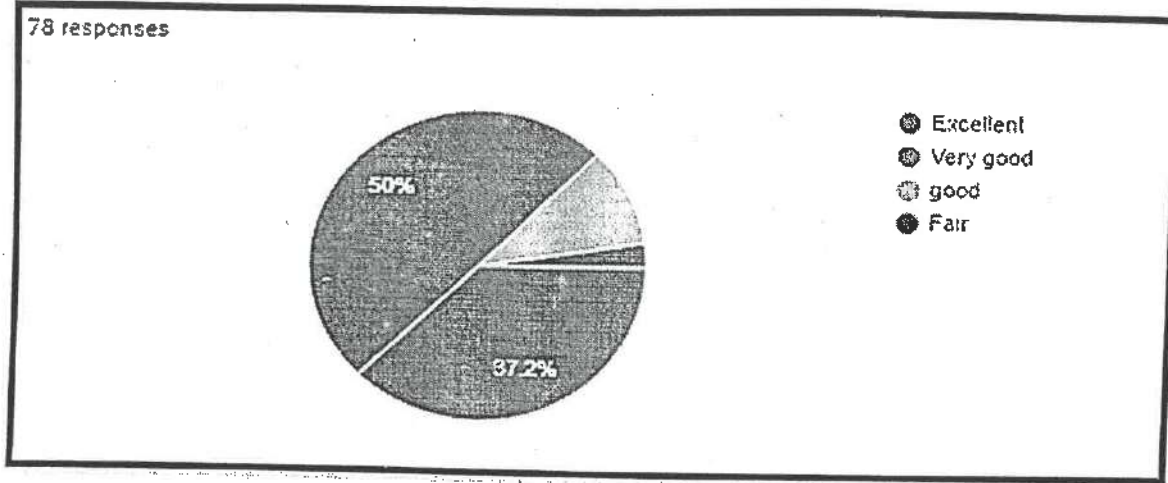

Overall how you rate the expert talk

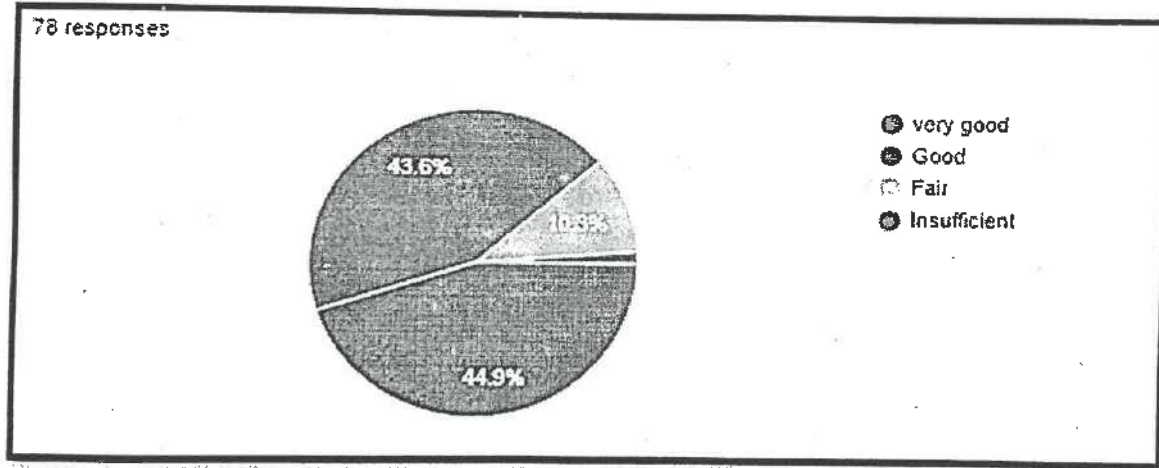

How interesting did the expert make the material



Does the speaker able to answer the questions from the audience?

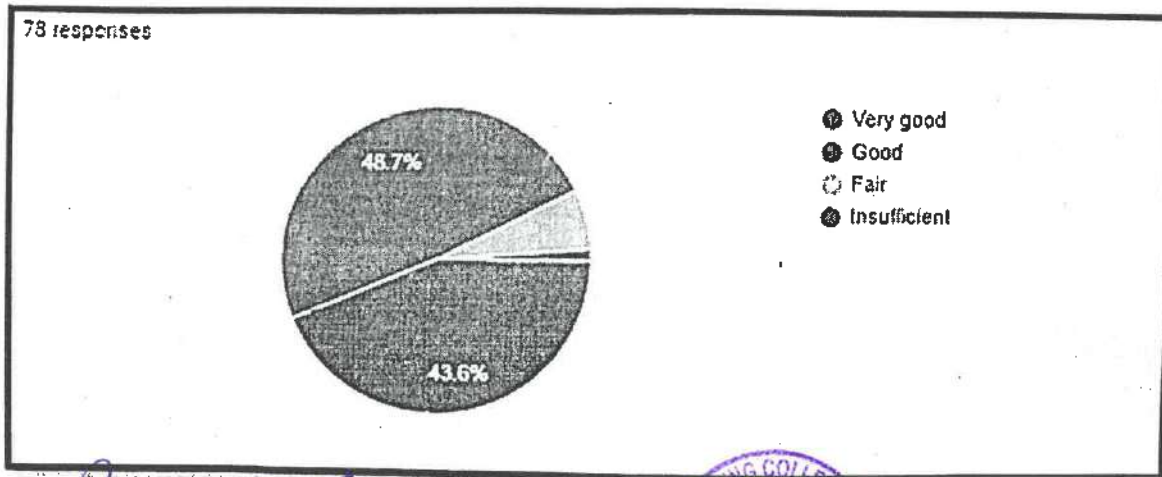

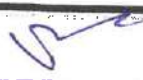

PRINCIPAL
TERNA ENGINEERING COLLEGE
Nerul, Navi Mumbai - 400 706



**Terna Engineering College
Department of Civil Engineering**

SEMESTER - VI

A.Y 2023-24

FH-24

Attendance Sheet

Roll No.	ID No	Student Name	Sign	Roll No.	ID No	Student Name	Sign
A01	TU7F2122001	TAMBE KSHITIJ	<i>Tambede</i>	A34	TU7S2223003	CHIRLEKAR AARYAN ANIL	<i>Chirlekar</i>
A02	TU7F2122002	MHATRE JATIN	<i>Mhatre</i>	A35	TU7S2223006	MANKUMBARE SOHAM MOHAN	<i>S.M.M.</i>
A03	TU7F2122003	CHIKANE ATHARVA		A36	TU7S2223005	SONAWANE KHUSHAAL BABAN	
A04	TU7F2122004	SHINDE MAYUR BABURAV	<i>Shinde</i>	A37	TU7S2223004	AMBHORE ARYAN ASHOK	
A05	TU7F2122005	CHOKALE HARSHAL	<i>Chokale</i>	A38	TU7S2223007	KHAN MEHTAB ALAM MUKHTAR AHMED KHAN	
A06	TU7F2122006	SHINDE AADITYA		A39	TU7S2223008	GHADI ANISH PRADEEP	<i>GHADI</i>
A07	TU7F2122007	KOLTE PRIYESH	<i>Kolte</i>	A40	TU7S2223009	PATIL KARTIK KIRAN	<i>K.Patil</i>
A08	TU7F2122009	CHINARATHOD VINOD	<i>Chinarathod</i>	A41	TU7S2223010	KENI VAIBHAVEE SUBODH	<i>Ken</i>
A09	TU7F2122010	GHONGE VIRAJ	<i>Ghonge</i>	A42	TU7S2223011	BOWLEKAR SHAILESH SHEKHAR	<i>Shilesh</i>
A10	TU7F2122011	JNGLE VIVEK SUDHAKAR	<i>Jungle</i>	A43	TU7S2223012	PALEKAR PRANAV ANIL	
A11	TU7F2122012	MHATRE SAI	<i>S.M</i>	A44	TU7S2223013	LAD AMEY MAHADEV	<i>Lad</i>
A12	TU7F2122013	DESHMUKH SHRADDHA SATISH	<i>Shraddha</i>	A45	TU7S2223014	DHUMAL CAURI SANJAY	<i>Dhumal</i>
A13	TU7F2122015	BODAKE JANARDAN	<i>Bodake</i>	A46	TU7S2223015	JADHAV SHRIYA VIVEK	<i>Jadhav</i>
A14	TU7F2122016	BHOSALE MAYUR		A47	TU7S2223016	PATIL SOHAM VINOD	<i>Patil</i>
A15	TU7F2122017	MUMBAIKAR VIPUL	<i>VM</i>	A48	TU7S2223017	BHUJBAL ARYAN CHANDRAKANT	
A16	TU7F2122018	PAUGHAN SPARSHA VILAS		A49	TU7S2223018	SINGH AYUSH JITENDRA	<i>Singh</i>
A17	TU7F2122019	KOLEKAR MAHESH	<i>M.R</i>	A50	TU7S2223019	GHANGALE ANAMAY UTTAM	<i>Ghangale</i>
A18	TU7F2122025	MANGLE MANAV	<i>Manav</i>	A51	TU7S2223020	DOMBARE VAISHNVI LAXMAN	<i>Dombare</i>
A19	TU7F2122024	KHANDAGALE ANOSH		A52	TU7S2223021	RANSHUR SAKSHI RAJU	<i>Sakshir</i>
A20	TU7F2122023	PATIL CHINMAY		A53	TU7S2223022	GHARAT PRANJALI MAHENDRA	<i>Gharat</i>
A21	TU7F2122022	AHIRWAR SHUBHAM	<i>Ahirwar</i>	A54	TU7S2223023	RATHOD SNEHAL SHIVAJI	<i>Rathod</i>
A22	TU7F2122021	SHINDE NEERAJ	<i>N.Shinde</i>	A55	TU7S2223024	KONDIKIRE MAYUR DILIP	
A23	TU7F2122020	MAGAR BHAIKAV		A56	TU7S2223025	YEDURKAR SEJAL RAMDAS	<i>Yedurkar</i>
A24	TU7F2122027	ANDHARE KAUSHAL ...	<i>Kaushal</i>	A57	TU7S2223026	CHORAGE AKASH AKARAM	<i>Chorage</i>
A25	TU7F2122028	TAMBE VEDANT	<i>Vedant</i>	A58	TU7S2223027	CHAUDHARI ATHARVA SANDEEP	<i>Chaudhary</i>
A26	TU7F2122030	GAVIT GAJENDRA	<i>Gavit</i>	A59	TU7S2223028	RAUT RUTUJA TUKARAM	<i>Raut</i>
A27	TU7F2122031	KAMBLE TANMAY	<i>Tanmay</i>	A60	TU7S2223029	MORE VINEET MILIND	<i>More</i>
A28	TU7F2122032	LUBAL SWAPNEEL		A61	TU7S2223030	KALE ATHARVA AMBADAS	<i>Kale</i>
A29	TU7F2122033	DHONE MAYUR	<i>Dhone</i>	A62	TU7S2223031	SHINDE SAHIL SANJAY	
A30	TU7F2122034	KARBHARI NIKHIL	<i>Karbhari</i>	A63	TU7S2223032	TAMBE ROHIT BABAN	<i>Tambe</i>
A31	TU7F2122036	SHIRSAT SHRUTI	<i>Shirsat</i>	A64	TU7S2223034	GAOKAR SANIKA DATARAM	<i>Gaokar</i>
A32	TU7F2122042	WALHEKAR PRACHI	<i>Walhekar</i>	A65	TU7T2324001	MASURKAR VIKRAM UDAY	
A33	TU7S2223001	SHINDE HARSH SANTOSH	<i>Shinde</i>				

Total students present

PRINCIPAL
TERNA ENGINEERING COLLEGE
Nand. Navi Mumbai - 400 706



5E

Terna Engineering College
Department of Civil Engineering

Attendance Sheet (A.Y 2023-24)

FH-24 (SEMESTER-IV)

Roll No.	ID No	Student Name	Sign	Roll No.	ID No	Student Name	Sign
A01	TU7F2122037	VERMA SAMAR		A31	TU7S2324011	CHANDAWALE ADITYA VIJAY	<i>Aditya</i>
A02	TU7F2122043	MUNDHE ROHAN	<i>Rohan</i>	A32	TU7S2324012	PARAB PREERNA KAMILAKAR	<i>Preerab</i>
A03	TU7F2223001	KARHADKAR ANANYA SHREENAND	<i>Ananya</i>	A33	TU7S2324013	MOKAL SANSKRUTI NARENDRA	<i>Sanskriti</i>
A04	TU7F2223002	MHATRE TEJAS CHANDRAHAS	<i>Tejas</i>	A34	TU7S2324014	BIKJE JAYSHI MAHESHI	<i>Jayshi</i>
A05	TU7F2223003	JUNDARE SUJAL PRAVIN		A35	TU7S2324015	KINDRE SAKSHI ANANT	<i>Sakshi</i>
A06	TU7F2223004	SHAIKH SAHIL RAJU		A36	TU7S2324016	VALVI VIPUL VIKRAM	
A07	TU7F2223006	THAKUR HIMANSHU DEEPAK	<i>Himanshu</i>	A37	TU7S2324017	JOSHI MAYURESH NILESH	<i>Mayuresh</i>
A08	TU7F2223010	ELEGAN SARVESH POSAMALLU		A38	TU7S2324016	HANAVARE PRAGATI MADHUKAR	<i>Pragati</i>
A09	TU7F2223013	MADACHANE SHARWARI SAGAR	<i>Sharwari</i>	A39	TU7S2324019	SHINDE TRUPTI ANIL	<i>Trupti</i>
A10	TU7F2223015	DESAI ANIRUDDHA AJIT	<i>Aniruddha</i>	A40	TU7S2324020	KOLI ANISHA RAJESH	<i>Anisha</i>
A11	TU7F2223019	MALAP AYUSH BHAGWAN	<i>Ayush</i>	A41	TU7S2324021	JUVALE KUNAL NARESH	
A12	TU7F2223020	PALVE PRATAP SHAMRAO	<i>Pratap</i>	A42	TU7S2324022	SALUNKHE SOHAM KRISHNA	<i>Soham</i>
A13	TU7F2223024	DESHMUKH PRATIK PRATAP	<i>Pratik</i>	A43	TU7S2324023	INGALE KOMAL SANJAY	<i>Komale</i>
A14	TU7F2223020	SINGH KARAN BIJAYENDRAPRATAP		A44	TU7S2324025	PATIL SHANTANU VIKAS	<i>Shantanu</i>
A15	TU7F2223032	MAKHJI MOHNISH SANDEEP	<i>Mohnish</i>	A45	TU7S2324026	KHATU SIDDHANT SACHIN	
A16	TU7F2223035	PARKAR TANVI VINAYAK	<i>Tanvi</i>	A46	TU7S2324024	SANAP VIDHITI BABASAHEB	<i>Banap</i>
A17	TU7F2223040	KURHADE CHAITALI HARISHCHANDRA	<i>Chaitali</i>	A47	TU7S2324027	NETAKE PREM KUNDALIK	<i>Netake</i>
A18	TU7F2223041	PASHTE VIRAJ RAVINDRA		A48	TU7S2324028	DHOVALE HRUSHIKESH SUBHASHI	
A19	TU7F2223042	GHADAGE PREM PRATAP	<i>Pratap</i>	A49	TU7S2324029	SHIRKE BHOOMI SANTOSH	<i>Bhoomi</i>
A20	TU7F2223043	KUMTHEKAR AADITYA SANJAY	<i>Aaditya</i>	A50	TU7S2324032	PATIL KSHITIJ UMESH	
A21	TU7S2324001	RAUT SAURABH VIKAS	<i>Saurabh</i>	A51	TU7S2324031	WARDE VAIBHAVI RAMESH	<i>Varde</i>
A22	TU7S2324002	PANVALKAR NINAD SUJARSHAN		A52	TU7S2324030	WAJGE YASH YOGESH	
A23	TU7S2324003	SADLE PRIYANSH VANDAN		A53	TU7S2324033	KAMBLE BHAGYASHRI BABASAHEB	
A24	TU7S2324004	CHAVAN VARUNRAJ BALU		A54	TU7S2324034	PATIL SAHIL PRAJHAD	<i>Sahil</i>
A25	TU7S2324005	GANGURDE CHAITANYA MAHESH GANGURDE	<i>Chaitanya</i>	A55	TU7S2324036	GURAV PRATIK SHASHIKANT	<i>Pratik</i>
A26	TU7S2324006	QURESHI MD RAZA PIROZ	<i>Piroz</i>	A56	TU7S2324030	SANGLE HIMANSHU MANGESH	
A27	TU7S2324007	TAKALE RUPALI DHULA	<i>Rupali</i>	A57	TU7S2324037	AHER SWARAJ GOLAB	
A28	TU7S2324008	KAMBLE OM SATISH		A58	TU7S2324035	BHOSALE ATHARV SANTAJI	
A29	TU7S2324009	TUPE SHUBHAM RAMESH	<i>Shubham</i>	A59	TU7S2324039	DESAI VAISHNAVI BALKRISHNA	<i>Vdesai</i>
A30	TU7S2324010	SHINDE RUCHA RAMESH					

Total students present



[Signature]
PRINCIPAL
TERNA ENGINEERING COLLEGE
Nerul, Navi Mumbai - 400 706